

Ohio Department of Commerce

Division of Industrial Compliance, Construction Compliance

6606 Tussing Road – P. O. Box 4009

Reynoldsburg, Ohio 43068-9009

(614) 644-3153 FAX (614) 995-1146

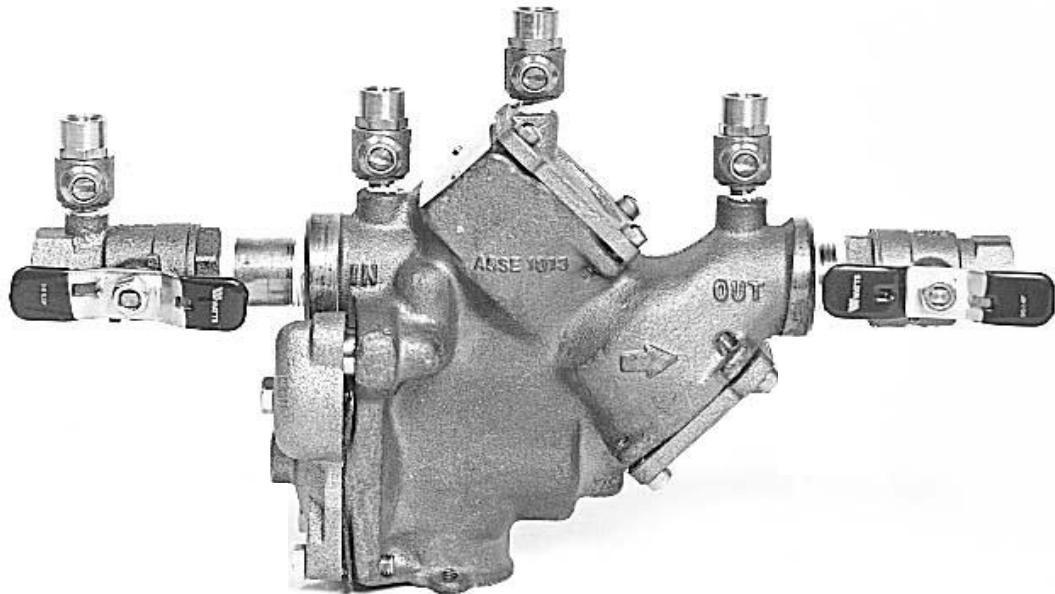

Backflow Prevention & Cross-Connection Control Manual *For the Education of Ohio Certified Backflow Prevention Technicians*

Administered by:

The Ohio Department of Commerce, Industrial Compliance, Backflow Section.

Manual Development Sponsored By:

**Ohio Department of Commerce
Ohio Department of Health
Ohio Environmental Protection Agency
Ohio Rural Water Association
Operator Training Committee of Ohio, Incorporated
Ohio Section, American Water Works Association**

Manual Oversight Committee:

**David Bornino, Ohio Environmental Protection Agency
Frank Czako, APHC Backflow School
Steve Heimlech, Ohio Section, American Waterworks Association
Ron Graves, Plumbers, Pipefitters and Service Technicians Local 189 JATC
Gary Espenschied, Operator Training Committee of Ohio, Inc.
Andy Provoznik, Ohio Rural Water association
Ralph Reeb, Ohio Department of Commerce
Dave Brown, Plumbers & Pipefitters Local 120
Joe Schmitt, PHCC of Ohio**

IN MEMORY...A Special Appreciation and Thanks to Jess Jones, Operator Training Committee of Ohio, Inc., for a lifetime commitment to the Water Purveyor and Backflow Industries****

TABLE OF CONTENTS

Table of Contents	3
Errata Sheet	4
About This Course	5
Introduction	6
Authority in Ohio	7
Responsibility	8-10
OTCO Training Agreement	11
Degree of Hazard	12
Definitions	13-19
Upstream vs Downstream	20
Atmospheric Pressure	21-22
Pressure & Elevation Head	23
Backsiphonage	24
Backpressure	25
Cross-Connections	26
Venturi Principle	27-28
Air-Gap Separation	29
ASSE 1013	30
ASSE 1015	31
ASSE 1001	32-33
ASSE 1020	34-37
Installation Requirements	38
Backflow Preventer Application	39
Backflow Prevention Devices	40-48
Backflow Application Chart	49-51
Thermal Expansion Control	52
Barometric Loop	53
Auxiliary Water Sources	54
Interchangeable Connectors	55
Low-Suction Pressure Cut-Off	56
Ohio Basic Building Code, Plumbing	57-63
Specific BFP Applications	64
Ohio Administrative Code, OEPA	65-74
Policy on Use of Antifreeze	75
Check List for Testers	76
3-Valve Analog Test Gauge	77
ASSE 1013 Test Procedures	78-79

ASSE 1015 Test Procedures	80-81
ASSE 1020 Test Procedures	82-83
ASSE 1056 Test Procedure	84-85
5-Valve Analog Test Gauge	86
ASSE 1013 Test Procedures	87-88
ASSE 1015 Test Procedures	89-90
ASSE 1020 Test Procedures	91-92
ASSE 1056 Test Procedure	93-94
Generic Test Form	95
Test Gauge Recalibration	96
ASSE 1013 Cross-Section	97
ASSE 1015 Cross-Section	98
ASSE 1020 Cross-Section	99
Tester Safety	100
Ohio Manufacturer Reps	101
Internet Web Sites	102
RP Parts Drawing	103
DC Parts Drawing	104
PVB Parts Drawing	105

**OHIO DEPARTMENT OF COMMERCE
BACKFLOW PREVENTION MANUAL**

ERRATA INFORMATION

See * page 4 for new information on expiration of grace period for renewal

See * page 10 for new information on penalties

OHIO DEPARTMENT OF COMMERCE BACKFLOW PREVENTION MANUAL

ABOUT THIS COURSE

This backflow prevention course is intended to prepare you to test/repair the various backflow prevention devices that are used to protect the public water supply. The course consists of a combined total of 24 hours of training in the classroom and the hands-on test lab.

This manual will be used as an instructional aid for the classroom portion of the course. Your Instructor will conduct the hands-on portion of the course in the test lab. You will have the opportunity to test, disassemble, reassemble and repair various backflow prevention devices.

If you successfully complete the hands-on testing proficiency test at the end of the course, then you will be permitted to take the Ohio Department of Commerce written test. Your Instructor will conduct the hands-on proficiency test and a representative of the Ohio Department of Commerce conducts the written test in Reynoldsburg, Ohio.

If you are successful on the written test, you will then be sent an application for submission with the required fees and then you will receive an identification card from the Ohio Department of Commerce indicating that you are certified by the State of Ohio to test backflow prevention devices.

You will be required to attend a Re-certification Course every three years to remain current, however you may attend the re-certification course more frequently provided space is available in the classes.

*There is a one-year grace period for re-certification and effective January 1, 2012 you will be required to retake the complete backflow certification course if you fail to recertify within one year of the expiration date of your certification. This means if you allow the grace period to expire then you must take the backflow prevention tester course again.

Your identification card will indicate the date that your certification expires or you can check the date on the Internet at www.com.state.oh.us.

OHIO DEPARTMENT OF COMMERCE BACKFLOW PREVENTION MANUAL

INTRODUCTION

Backflow can be defined as the unintentional reversal of the normal direction of flow within a piping system. When there are cross-connections in the consumer's water distribution system, either actual or potential cross-connections, a substance can be introduced into the piping.

Substances that may backflow into a potable water distribution system can be prevented from entering the system through the proper application of an approved air-gap separation or any number of other approved backflow prevention devices that are commercially available.

This manual is intended to make you aware of the hazard associated with a backflow condition and the available methods and/or devices that may be used to properly protect the water distribution system.

Additionally the information contained in this manual and your hands-on training during the class will prepare you for the Ohio Department of Commerce "Backflow Technician" exam. Successful completion of the training course and the written test will result in a State Certification that is valid for a three year period.

Backflow prevention is a joint responsibility of the regulatory authorities, the local plumbing inspection officials, the water supplier, and the consumer. Each has a role in the eliminating the possibility of backflow.

You, the plumbing trades, are a primary figure in backflow prevention. You are the individual who sees the problem first-hand and on-site. The owner, water supplier and plumbing inspector will depend upon you to recognize a problem and bring it to their attention.

OHIO DEPARTMENT OF COMMERCE BACKFLOW PREVENTION MANUAL

AUTHORITY IN OHIO

In the State of Ohio there are two Regulatory Agencies that oversee the potable water supply.

The Ohio Environmental Protection Agency has the authority over the public water system from the source to the service connection, which is defined in Ohio Administrative Code as the outlet side of the water meter.

The water supplier acts as the enforcement officer for the Ohio EPA. The water supplier uses the containment principle of backflow prevention to protect the public water supply from backflow. The containment principle backflow prevention assembly remains under the authority of the water supplier even though it may be installed inside the building.

The Ohio Department of Commerce, Industrial Compliance Division has the authority over the consumer's water distribution system, which begins at the water meter and includes all piping and fixtures in the building.

The local plumbing official acts as the enforcement officer for the Ohio DOC. The plumbing official uses the isolation principle of backflow prevention to protect the consumer's water system.

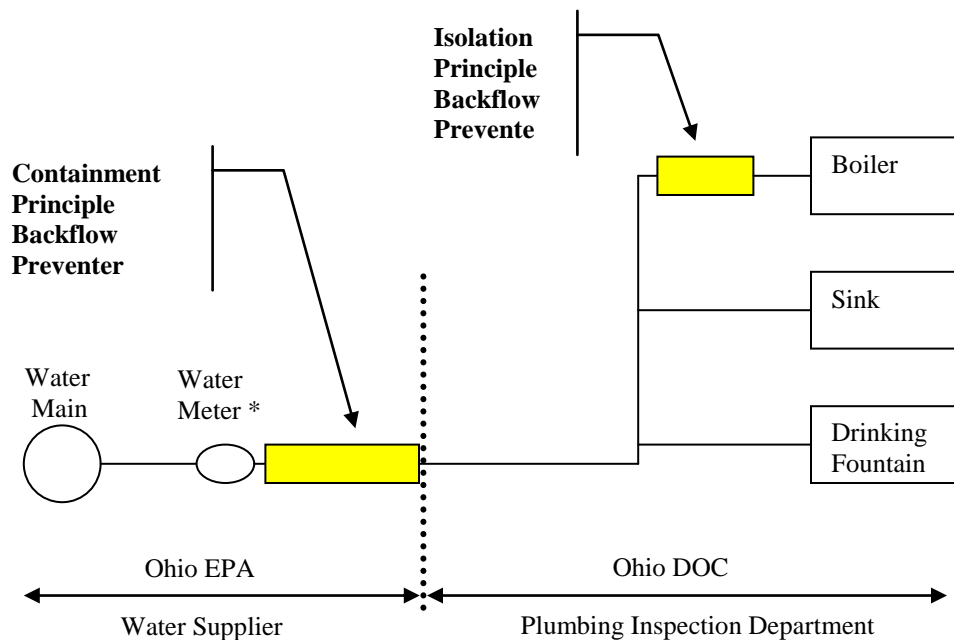

- If the water meter is installed inside the building then the containment principle backflow preventer must be installed immediately after the water meter. If the meter is installed outside the building then the containment principle backflow preventer is typically installed inside the building wall unless otherwise approved by the water supplier.

Figure 1

OHIO DEPARTMENT OF COMMERCE BACKFLOW PREVENTION MANUAL

RESPONSIBILITY

The responsibility for backflow prevention rests jointly with the supplier of water, the water consumer, the plumbing inspection agencies and the Regulatory Agencies. The Regulatory Agencies include the Ohio Environmental Protection Agency and the Ohio Department of Commerce.

Backflow prevention may be divided into two areas of protection.

One is the protection of the public potable water system, which is the responsibility of the supplier of water.

The other is the protection of the consumer's potable water system, which is the responsibility of the consumer-owner of the premises and the plumbing inspection agencies.

Supplier of Water

The supplier of water has the primary responsibility for providing the consumer with a safe and potable water supply. This responsibility begins at the source, includes all of the public water distribution system and service connections, and ends at the point of delivery to the consumer. The point of delivery to the consumer is defined in the Ohio Administrative Code as the service connection or the outlet side of the water meter.

The supplier of water must use reasonable care and vigilance to protect the public water system from hazards originating within the consumer's system that could contaminate the water in the public water system.

The Water Consumer

The water consumer has the dual responsibility of protecting the water users within his own premises and of protecting the public water system from contamination originating from conditions on the premises. This responsibility begins at the service connection and includes the entire consumer's distribution system.

The water consumer is liable for any installation on his premises that could endanger the water quality of either the public or consumer's distribution system.

OHIO DEPARTMENT OF COMMERCE BACKFLOW PREVENTION MANUAL

RESPONSIBILITY

The Plumbing Inspection Authorities

The plumbing inspection authorities have a responsibility of inspecting the consumer's water distribution system to ensure that all cross-connections within the premises are protected from backflow.

The plumbing inspection authorities are responsible for the inspection of the consumer's potable water system and ultimately share a liability with the owner and the design professional for the protection of the internal water distribution system.

The plumbing inspection authorities meet this responsibility by inspecting all new construction to ensure that all cross-connections are properly protected. They then must review the plans for all plumbing permits to ensure that no new cross-connections are installed without the appropriate protection.

The Regulatory Agencies

The regulatory agencies are responsible for enforcing Ohio's laws, rules and regulations related to backflow prevention.

The Ohio Department of Commerce oversees the plumbing inspection agencies, which have the inspection authority and responsibility to protect the users within the premises.

The Ohio Environmental Protection Agency oversees the water suppliers, who have the authority and responsibility to protect the integrity of the public water distribution system.

OHIO DEPARTMENT OF COMMERCE BACKFLOW PREVENTION MANUAL

RESPONSIBILITY

The Certified Technician's Responsibility

The technician is responsible to properly test and report the status of each device tested and accurately record the test results. He will furnish a copy of the test report to the owner or representative of the owner, to the agency requiring the test, and a retain copy for their records.

*If the technician fails in this responsibility, fraudulently fills out the test report, fails to test a device and reports it as tested, or other fraudulent activity in the testing and/or repairing of a device then there will be an advisory committee meeting(s) to determine the seriousness of the activity and could result in the action being taken as specified in the SUSPENSION GRID TABLE below.

It is the responsibility of the technician to be completely knowledgeable about regulations, rules or requirements of the Ohio Regulatory Agencies and local authorities that may be required as to registrations, requirements or additional certifications to work on specific systems before performing the testing and repair of the backflow devices.

Water Department backflow prevention program employees are permitted to take the Ohio DOC exam, if they are approved by the OCTO board and meet all the necessary requirements. They are then eligible to test isolation backflow prevention assemblies, but only in their city-owned buildings. To ensure compliance, they are required to sign and have the following codicile notarized. (pg 11)

*The following table is the mandatory penalties for falsification of backflow testing documentation.

***SUSPENSION GRID FALSIFICATION OF DOCUMENTATION**

1st Offense	12 Month Suspension & Attend Recertification Class
2nd Offense	24 Month Suspension & Attend Full Certification Class No reexamination required
3rd Offense	Lifetime Suspension of Certification

*These are penalties that are assessed by the Department of Commerce and are separate from any that can or will be assessed by the Ohio EPA in their investigation of the allegations of falsification of documentation when it involves the containment backflow device.

Operator Training Committee of Ohio, Inc.

TERMS OF AGREEMENT

Article 1. In consideration of being recommended to the Ohio Department of Commerce for the Backflow Technician Certification Exam by the OTCO Backflow Prevention Advisory Board;

I acknowledge that the Ohio Department of Commerce Backflow Technician certification permits me to test only those isolation backflow prevention assemblies that are located within city owned public buildings, in the normal course of my employment, and my normal duties with the Public Water Supplier;

Article 2. I acknowledge and understand that I am not authorized to perform any test of an isolation backflow prevention assembly for personal profit outside of the normal course of my employment and the normal course of my duties as an employee of the Public Water Supplier;

Article 3. I acknowledge and understand that my Ohio Department of Commerce "Backflow Technician" certification may be revoked if I am found to be in violation of any article of this agreement;

Article 4. The members of the OTCO Backflow Prevention Advisory Board, the Operator Training Committee of Ohio, Incorporated, its Board Members, Officers, Employees and Instructors, and the Ohio Department of Commerce, its Officers and Employees, shall be held harmless in any dispute concerning my Ohio DOC "Backflow Technician" certification;

Article 5. I acknowledge and understand that this Agreement shall be complete and binding.

I solemnly swear and that I have read, understand and agree to the terms of this agreement between the Backflow Prevention Advisory Board of the Operator Training Committee of Ohio, Incorporated, the Ohio Department of Commerce, and myself.

Signature: _____ **Date:** _____

Sworn to and subscribed before me according to law this _____ day
Of _____, 20_____

Place

County of _____ State of _____

Notary Seal

Officer: _____

Here

OHIO DEPARTMENT OF COMMERCE BACKFLOW PREVENTION MANUAL

DEGREE OF HAZARD

The type of backflow prevention device that will be required at the water meter or at an individual fixture is determined by evaluating the degree of hazard that is presented.

When we speak of evaluating the degree of hazard, we are going to determine the potential for backflow to occur (can backflow happen) and the toxicity of the contaminant that could backflow (how toxic is the substance that can backflow into the piping).

The Plumbing Inspection Authority under the direction of the Ohio Department of Commerce determines the degree of hazard presented by the individual fixtures within the premises. Based upon this evaluation, they determine the appropriate isolation principle backflow prevention device that must be installed at the fixture.

The Water Supplier under the direction of the Ohio Environmental Protection Agency determines the total degree of hazard presented by the premises and determines the appropriate containment principle backflow prevention assembly that must be installed at the water meter.

Although the Ohio Department of Commerce and Ohio Environmental Protection Agency has different levels of degree of hazard, there is a correlation between the two agencies as indicated in the following chart.

Degree of Hazard Evaluation Terms

Ohio Department of Commerce

Ohio Environmental Protection Agency

Low Hazard = Pollution Hazard (aesthetically objectionable)

High Hazard = System Hazard (may cause damage to the system piping)
“ = Health Hazard (is a threat to the health of the water user)

Severe High Hazard = Severe Health Hazard (presents a threat of death)

With a recommendation for an approved air-gap separation:

1. Pump packing gland seal on a sewage lift pump
2. Any system containing ethylene glycol antifreeze

OHIO DEPARTMENT OF COMMERCE

BACKFLOW PREVENTION MANUAL

DEFINITIONS

<u>Absolute Pressure</u>	The total pressure; gauge pressure plus atmospheric pressure. Absolute pressure is generally measured in pounds per square inch, and is indicated as pounds per square inch absolute (psia).
<u>Air-Gap Separation</u>	The unobstructed vertical distance through the free atmosphere between the lowest opening from any pipe or outlet supplying water to a tank, plumbing fixture, or other device, and the flood level rim of the receptacle
<u>Approved Air-Gap Separation</u>	An approved air-gap separation is a distance through the free atmosphere equal to two times the nominal diameter of the supply pipe discharge opening, but never less than one inch
<u>Atmospheric Pressure</u>	The pressure exerted by the weight of the atmosphere (14.7 psig) at sea level). As the elevation above sea level increases, the atmospheric pressure decreases.
<u>Atmospheric Vacuum Breaker</u>	A mechanical device consisting of a float check valve and an air-inlet port designed to prevent backsiphonage.
<u>Auxiliary Water System</u>	Any water system on or available to the premises other than the public water system. These auxiliary water systems shall include used water or water from a source other than the public water system, such as wells, cisterns or open reservoirs that are equipped with pumps or other prime movers, including gravity.
<u>Backflow</u>	The unintentional reversal of the normal direction of flow in a potable water system that may result in the pollution or contamination of the system by a liquid, gas, solids, or mixtures.
<u>Backflow Prevention Device</u>	Any device, method, or type of construction that is used to prevent a backflow condition into a potable water system.
<u>Backpressure Backflow</u>	A reversal of the normal direction of flow in a water system due to an increase in downstream pressure above that of the supply pressure. The greater pressure can cause a non-potable substance to backflow into the potable water system through unprotected cross-connections.
<u>Backsiphonage Backflow</u>	A reversal of the normal direction of flow in the piping due to a drop in supply pressure, a vacuum, or a negative pressure in the supply piping.

OHIO DEPARTMENT OF COMMERCE

BACKFLOW PREVENTION MANUAL

DEFINITIONS

<u>Booster Pump</u>	Any device which is intended to increase the in-line water pressure.
<u>Bypass</u>	Any arrangement of pipes, plumbing, or hoses which are designed to divert the flow around an installed backflow prevention device through which the flow normally passes.
<u>Consumer's Water System</u>	Any water system located on the consumer's premise that is supplied by or is connected in any manner to a public water system.
<u>Containment Principle Backflow Prevention Device</u>	A backflow prevention device that is installed in a water system at the outlet side of the water meter and is intended to contain the water within the building; to prevent any polluted or contaminated water from backflowing into the public water system.
<u>Contaminant</u>	Any liquid, solid, or gas that presents an actual threat to the health or well being of the consumer.
<u>Contamination</u>	The introduction of a liquid, solid, or gas that subjects the consumer to potentially lethal waterborne diseases, or illness.
<u>Continuous Pressure</u>	As applied to backflow prevention devices it means water pressure supplied to a device for greater than twelve (12) hours
<u>Critical Installation Level</u>	The critical installation level is the prescribed height that a vacuum breaker or other appurtenance must be installed above the flood level rim of the fixture or receptacle being supplied. If this height is not maintained, then the device may not provide the intended protection. The critical installation level for a vacuum breaker is the bottom of the device when it is not indicated on the body.
<u>Cross-Connection</u>	Any arrangement of pipes, fittings, fixtures, or devices that connects a non-potable system to a potable system. It is the piping arrangement that will allow backflow to occur.
<u>Cross-Connection Control</u>	The use of a device, method, or procedure to prevent backflow into a potable water system through a cross-connection.
<u>Degree of Hazard</u>	A term used to describe the evaluation of the potential risk to health and/or the adverse effect upon a potable water system; or a determination of whether a substance is toxic or non-toxic.
<u>Differential Pressure Gauge</u>	A testing device that measures two separate pressures and indicates the difference between the two; differential pressure is indicated as pounds per square inch differential (psid).

OHIO DEPARTMENT OF COMMERCE BACKFLOW PREVENTION MANUAL

DEFINITIONS

<u>Direct Connection</u>	Any arrangement of pipes, fixtures, or devices that connects a non-potable source to a potable water system; such as a boiler feed line.
<u>Distribution System</u>	All pipes, fittings, and fixtures used to convey liquids, solids, or gases from one point to another.
<u>Double Check Valve Assembly</u>	A backflow prevention device consisting of two spring-loaded, independently acting check valves set in series, a tightly closing inlet and outlet valve, and four appropriately located test cocks.
<u>Double Check Detector Check Assembly</u>	Means a specially designed assembly composed of a line-sized approved double check valve assembly with a specific bypass water meter and a meter-sized approved double check valve assembly. The meter shall register accurately for only very low rates of flow and shall show a registration for all rates of flow.
<u>Ethylene Glycol</u>	A substance that is added to water to decrease the temperature at which the water will freeze; ethylene glycol presents a severe high hazard.
<u>Flood Level Rim</u>	The maximum height that the fluid level may reach in a vessel.
<u>Gauge Pressure</u>	The pounds of pressure per square inch or psig as registered on a gauge; indicating the amount of pressure above or below atmospheric pressure.
<u>Health Hazard</u>	<p>A term used by the Ohio EPA to describe a degree of hazard that is defined as any condition, device or practice in a water system or it's operation that creates a threat to the health and well-being of it's users.</p> <p>The Ohio DOC equivalent is a high hazard.</p>
<u>High Hazard</u>	<p>An actual or potential threat of contamination of the potable water system that would present a threat to the health of the consumer.</p> <p>The Ohio EPA equivalent is a system, or health hazard.</p>
<u>Low Hazard</u>	<p>An actual or potential threat to the potable water system whereby the risk from backflow would be limited to the pollution of the potable system by an aesthetically objectionable but non-toxic substance, such as beverages, foods or other non-toxic substances.</p> <p>The Ohio EPA equivalent is a pollution hazard.</p>

OHIO DEPARTMENT OF COMMERCE

BACKFLOW PREVENTION MANUAL

DEFINITIONS

Indirect Connection

Any arrangement of pipes, fittings, or fixtures that indirectly connects a potable water system to a non-potable source, such as a flushometer valve to a water closet.

Isolation Principle Backflow Prevention Device

A backflow prevention device installed at the supply line to a fixture. It is intended to isolate that fixture from the other fixtures within the building, and to prevent backflow from that fixture into the potable water system; such as backflow prevention device on a laboratory faucet or boiler feed line.

Liability

An obligation by law, or a responsibility to perform according to generally accepted practices. *SEE PAGE 10 TECHNICIAN'S RESPONSIBILITY*

Negative Pressure

Any pressure that is less than the prevailing atmospheric pressure; a negative pressure in a piping system can induce a vacuum that could siphon non-potable substances into the potable water system.

Non-Potable

Any substance that is unsafe for human consumption or culinary purposes.

Non-Toxic Substance

Any substance that may create a low degree of hazard, is a nuisance, is aesthetically objectionable, or degrades the water quality but poses no threat to the health of the consumer.

Physical Disconnection (Separation)

The removal of pipes, fittings, or fixtures that connect a potable water system to a non-potable source or one of questionable quality.

Plumbing

Any arrangement of pipes, fittings, fixtures or devices intended to move a liquid, solid, or gas from one point to another (generally within a single premises or structure).

Poison

A substances that can kill, permanently injure, or impair a living organism

Pollution

An actual or potential threat by a substance that does not present a threat to the health of the consumer but is aesthetically objectionable or impairs the quality of the water with respect to taste, odor or color.

Pollution Hazard

A term used by the Ohio EPA to describe the degree of hazard of a substance that tends to degrade the water quality but poses no threat to health.

The Ohio DOC equivalent is a low hazard.

OHIO DEPARTMENT OF COMMERCE BACKFLOW PREVENTION MANUAL

DEFINITIONS

<u>Potable Water</u>	Water intended for human consumption.
<u>Premises</u>	Means any building, structure, dwelling or area containing plumbing or piping supplied from a public water system.
<u>Pressure Relief Valve</u>	A pressure actuated valve that is held closed by a spring or other means and is designed to relieve pressure automatically at a predetermined pressure setting.
<u>Pressure Vacuum Breaker</u>	A backflow prevention device consisting of one or two independently acting, spring-loaded check valves, and an independently acting, spring-loaded air inlet valve designed to prevent backsiphonage.
<u>Process Fluids</u>	Means any fluid or solution which may be chemically, biologically or otherwise contaminated or polluted in a form or concentration such as would constitute a pollution, system or health hazard if introduced into the public or a potable consumer's water system. This includes but is not limited to: <ol style="list-style-type: none">(1) Process waters(2) Used waters originating from the public water system which may have deteriorated in sanitary quality(3) Cooling waters(4) Natural waters taken from wells, lakes, ponds, or streams
<u>Propylene Glycol</u>	A substance that is added to water to decrease the temperature at which the water will freeze: though an approved substance to be used around food it is considered needing high hazard protection.
<u>Reduced Pressure Principle Backflow Preventer</u>	A mechanical backflow prevention assembly consisting of two independently-acting, spring-loaded check valves; four appropriately located test cocks; a tightly-closing inlet and outlet valve; and a pressure relief valve mechanism located between the two check valves that is designed to maintain the pressure between the check valves at least 2 pounds lower than the supply pressure to the device.
<u>Refusal of Service</u>	A formal policy adopted by a governing board to enable a utility to refuse or discontinue water service where a known hazard exists and corrective measures are not taken.
<u>Regulating Agency</u>	Any local, state, or federal authority given the power to issue rules or regulations having the force of law for the purpose of providing uniformity in procedures or detail.

OHIO DEPARTMENT OF COMMERCE BACKFLOW PREVENTION MANUAL

DEFINITIONS

<u>Relief Valve</u>	A device designed to maintain a designated maximum or minimum pressure in a water system by the release of pressure or the introduction of atmospheric air, respectively.
<u>Service Connection</u>	Is the terminal end of a water service line from the public water system. If a water meter is installed at the end of the service then the service connection means the downstream end of the water meter.
<u>Severe Health Hazard</u>	<p>A term used by the Ohio EPA to describe a degree of hazard that is defined as a threat to the health of a user that could be reasonably expected to result in significant morbidity or death.</p> <p>The Ohio DOC equivalent is a severe high hazard with a recommendation for an approved air-gap separation.</p>
<u>Solar Heating System</u>	A system designed to capture ambient heat from the sun and transfer that heat through a fluid medium. A chemically treated system must be protected with a reduced pressure principle backflow preventer otherwise a double check valve assembly is acceptable protection.
<u>Submerged Inlet</u>	An arrangement of pipes, fittings, or devices that introduces potable water into a non-potable system below the flood level rim of the receptacle being supplied.
<u>System Hazard</u>	<p>A term used by the Ohio EPA to describe a threat to the physical properties of the public water system or a consumer's potable water system.</p> <p>The Ohio DOC equivalent is a high hazard.</p>
<u>Temperature Relief Valve</u>	A temperature actuated valve that is designed to discharge automatically at the temperature at which the valve is set.
<u>Temperature & Pressure Relief Valve</u>	A combination relief valve that is designed to function as both a temperature relief valve and a pressure relief valve.
<u>Thermal Expansion</u>	Thermal expansion is the physical property for water to increase in volume when it is heated.
<u>Toxic Substance</u>	Any liquid, solid, or gas which if introduced into the water supply would create a danger to the health and well being of the consumer.

OHIO DEPARTMENT OF COMMERCE BACKFLOW PREVENTION MANUAL

DEFINITIONS

Used Waters

Means the water supplied by the public water system after it has passed through the service connection and is no longer under the control of the water supplier.

Vacuum (Partial Vacuum)

A hydraulic condition created when the pressure in a system drops below the prevailing atmospheric pressure

Venturi Principle

A hydraulic principle that can create a siphon utilizing the flow of the water in the piping. The principle states that as a liquid flows through a constriction in the piping, the velocity of flow will increase and the fluid pressure will decrease at the constriction.

Vacuum Relief Valve

A relief valve that is installed in a pressurized system to prevent the occurrence of a vacuum developing in that system upon a loss of pressure in the supply piping.

OHIO DEPARTMENT OF COMMERCE BACKFLOW PREVENTION MANUAL

UPSTREAM VS DOWNSTREAM

Upstream always refers to the supply side (water main side) of any appurtenance connected to the water supply system.

Downstream always refers to the discharge side (user's side) of any appurtenance connected to the water supply system.

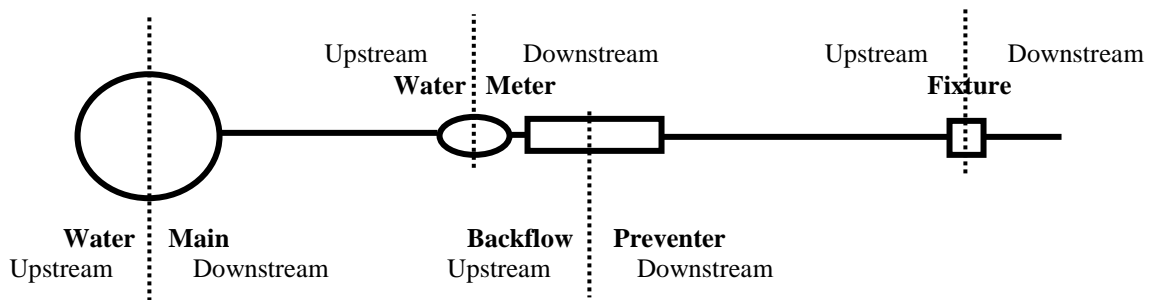

Figure 2

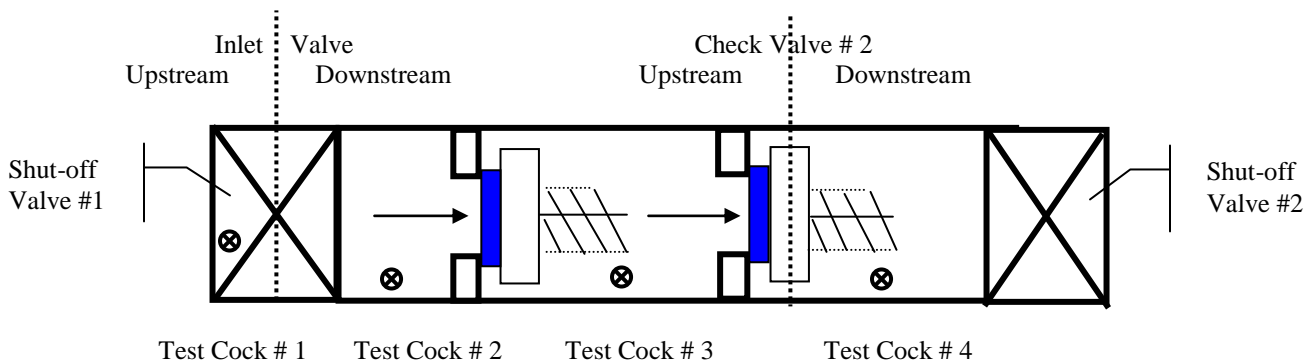

Figure 3

Upstream/Downstream Memory Shortcut: Up and In - Down and Out

Remember that on an ASSE 1015, 1013, 1047, or 1048:

- Test cock number 1 is always upstream of shut-off valve 1
- Test cock number 2 is always upstream of check valve 1
- Test cock number 3 is always upstream of check valve 2
- Test cock number 4 is always upstream of shut-off valve 2

OHIO DEPARTMENT OF COMMERCE BACKFLOW PREVENTION MANUAL

ATMOSPHERIC PRESSURE

The air surrounding the earth has a weight sufficient to exert a pressure of 14.7 pounds per square inch at sea level. This atmospheric pressure is equivalent to the pressure exerted by a column of water 34 feet high. Figure 3 shows the theoretical balance between atmospheric pressure and a column of water.

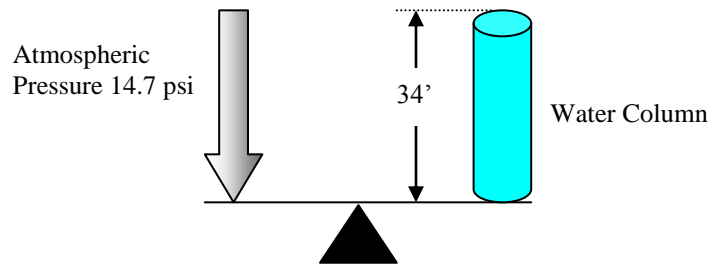

Figure 4

The balancing of forces is also shown in Figure 4. When a long tube closed at one end is filled with water and inverted in an open container of water, the water level in the tube will be higher than the water level in the open container. The weight of the atmosphere pressing down on the water surface in the container will hold the water in the tube up to a maximum elevation of 34 feet. One pound per square inch of pressure will elevate water to a height of 2.31 feet.

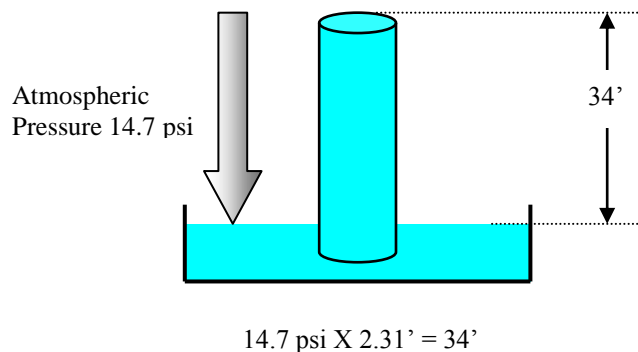

Figure 5

OHIO DEPARTMENT OF COMMERCE BACKFLOW PREVENTION MANUAL

ATMOSPHERIC PRESSURE

Pressure less than atmospheric pressure is called negative pressure or vacuum. A vacuum can be defined as any location in a piping system where the pressure is less than the prevailing atmospheric pressure.

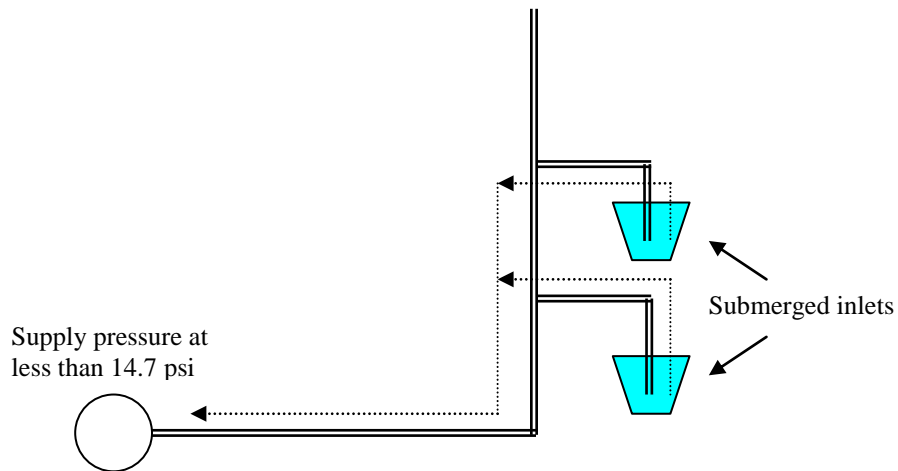

Figure 6

OHIO DEPARTMENT OF COMMERCE BACKFLOW PREVENTION MANUAL

PRESSURE & ELEVATION HEAD

Pressure head is the force, usually from a pump, that pushes the water forward. It takes one pound of pressure head to lift a column of water 2.31' or 28" high. Pressure head is diminished by frictional loss as the water travels through the pipe or a fixture, but these losses are usually minimal.

So to lift the water through the consumer's piping to the second floor would cause a loss of 1 pound of pressure for every 2.31' or 28" high that the water has to be elevated.

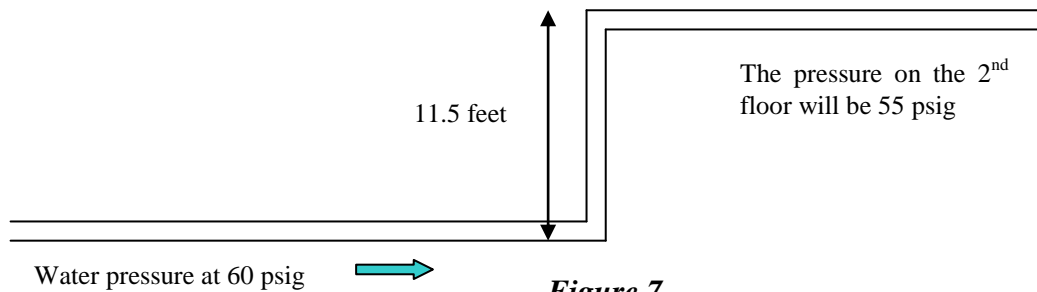

Figure 7

Water pressure minus (elevation ÷ 2.31') = pounds of pressure lost to lift the water in the piping 60 psig minus (11.5' ÷ 2.31') = 55 psig or 60 psig minus (elevation x .433) 4.98 = 55psig

Elevation head is the force of the weight of the water in the piping. A column of water 1' high has a pressure at its base of .433 psig. If you put another 1' column of water on top of the first column, the pressure at the base is now .866. Each additional 1' column of water adds an additional .433 psig pressure at the base

So a column of water 2.31' or 28" high exerts a force of 1 psig at its base. If you add another 2.31' column of water on top of the first column, the pressure at the base is now 2 psig; so for each additional 2.31' of water there is an additional 1 psig added at the base.

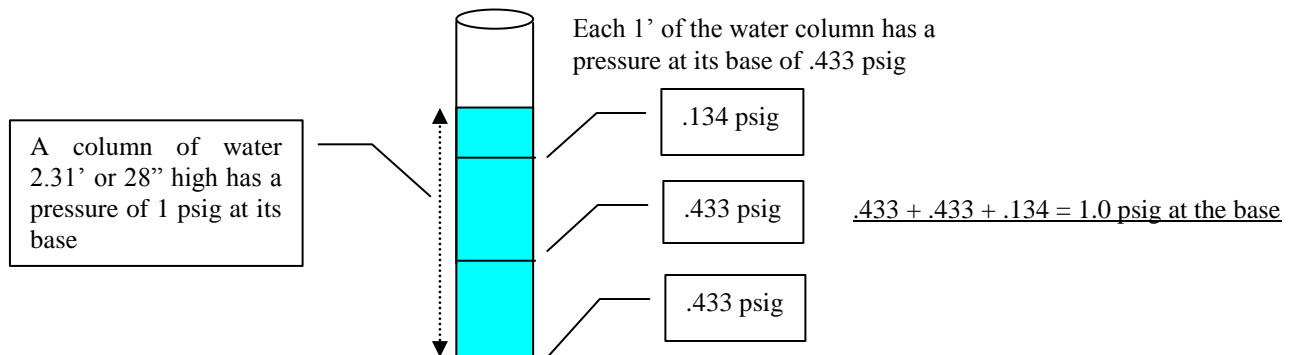

Figure 8

Pressure/Elevation Memory Shortcut: 1 Foot of Elevation equals .433 Pounds of Pressure

OHIO DEPARTMENT OF COMMERCE BACKFLOW PREVENTION MANUAL

BACKSIPHONAGE

Backsiphonage is one of the two hydraulic principles that can cause backflow to occur.

It is a reversal of the normal direction of flow in a piping system due a drop in the supply pressure, a vacuum or a negative pressure in the piping system.

Backsiphonage always results when a vacuum, a partial vacuum or a negative pressure occurs in the supply piping. A vacuum is defined as any point in a water piping system where the pressure is less than the prevailing atmospheric pressure (14.7 psi at sea level).

An unprotected cross-connection may allow a contaminant or pollutant to backflow into the potable water system due to backsiphonage.

Backsiphonage can be caused by a water main break in the public water system; by a break in the consumer's piping; if the water is turned off for maintenance or repair; if a fire hydrant is struck; if the fire department is drawing water to fight a fire; or by an abnormally heavy water use in the supply piping.

Remember that a liquid will flow in the direction of the lesser pressure. So if the pressure drops on the upstream or supply side then the direction of flow will be reversed.

Backsiphonage occurs most frequently within the consumer's system and primarily from the higher points in the building.

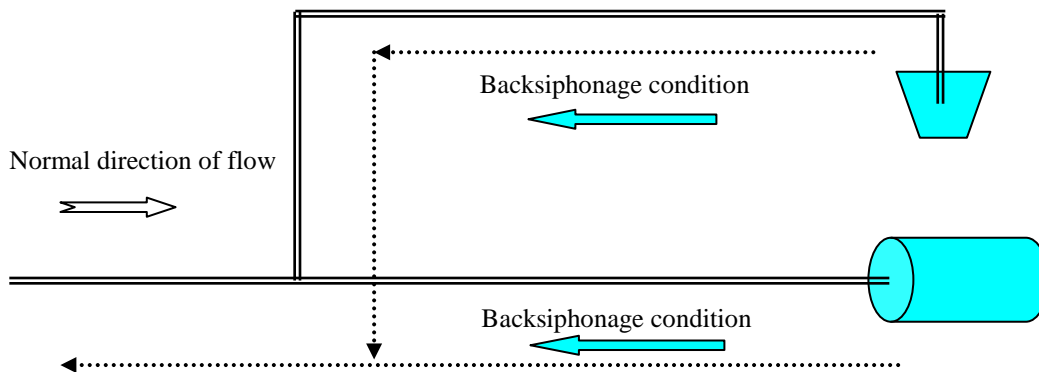

A drop in the supply pressure in the water main or in the consumer's internal piping will cause a reversal of flow in the piping due to backsiphonage.

Figure 9

OHIO DEPARTMENT OF COMMERCE BACKFLOW PREVENTION MANUAL

BACKPRESSURE

Backpressure is the other hydraulic principle that can cause backflow to occur.

It is a reversal of the normal direction of flow due to a downstream pressure that is greater than the supply pressure.

When the pressure is greater in a consumer's distribution system than the pressure in the public water system, then the water will reverse its normal direction of flow and flow towards the public water system. Unless, an isolation principle backflow prevention device has been installed at the plumbing fixture that contains the higher pressure.

Backpressure can be created by boilers, chillers, internal pumping systems, or any other system that can create a pressure that is greater than the normal supply pressure.

So if a system creates a pressure greater than the supply pressure then there will be backflow unless the appropriate isolation principle backflow prevention device is installed.

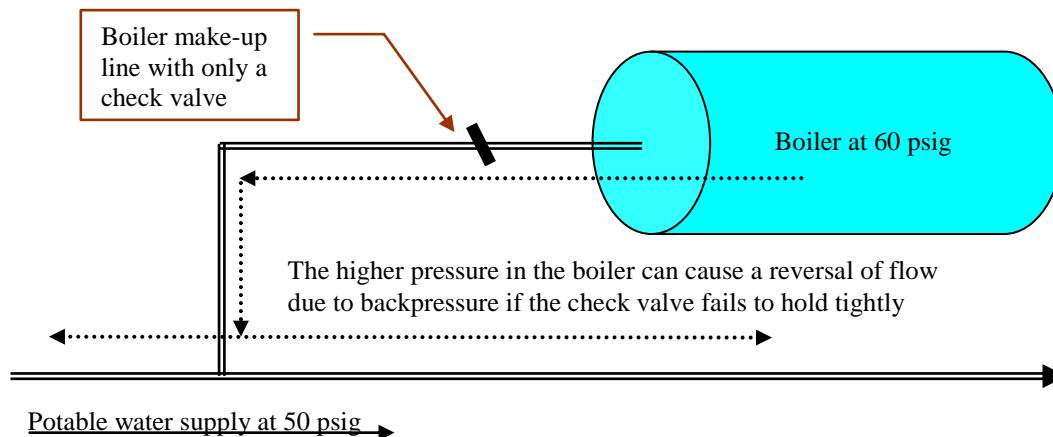

Figure 10

OHIO DEPARTMENT OF COMMERCE BACKFLOW PREVENTION MANUAL

CROSS-CONNECTIONS

A cross-connection is any connection between the potable water supply and a source of pollution or contamination. It can be permanent or temporary; direct or indirect; actual or potential.

Another definition is any arrangement whereby backflow can occur.

A cross-connection is the point at which a water-using fixture is connected to the consumer's potable water system.

Some of the more common examples are:

- boiler make-up lines
- chiller make-up lines
- tanks or vats with a submerged inlet
- x-ray & photo developing equipment
- irrigation systems
- pressure washers
- commercial grade dishwashers
- commercial grade garbage disposals or grinders
- soap, sanitizer or wax education systems
- a janitor's sink with a hose attached
- hose bibs with hose attached

OHIO DEPARTMENT OF COMMERCE BACKFLOW PREVENTION MANUAL

VENTURI PRINCIPLE

One of the basic principles of Fluid Mechanics is the Principle of Fluid Motion. The premise of this principle is that as a fluid flows through a constriction in the piping, its velocity increases which reduces the pressure at the constriction; thereby a siphon or vacuum is created at the constriction. Using this principle, a fluid may be added to the water using only atmospheric pressure.

This apparatus may be called a venturi, a suction tee, an eductor or an aspirator. The problem with this apparatus is that if a backsiphonage should occur, then the fluid being added would also be backsiphoned.

You will find this principle of eduction in use at the following applications, as well as many others:

- commercial dishwashers: used to add soap, sanitizer and rinse agents
- car washes: used to add soap and wax
- dentist offices: often used to suction saliva from the mouth
- butcher shops: used to add soap, sanitizer and degreaser to the hose used for washing the floor
- industry: used to add solvents to various dip tanks
- mortuaries: used to siphon body fluids during embalming process
- hospital autopsy rooms: used to siphon body fluids and other debris during autopsy
- residential: lawn & garden sprayers
- irrigation systems: used to add fertilizer, herbicide or insecticide

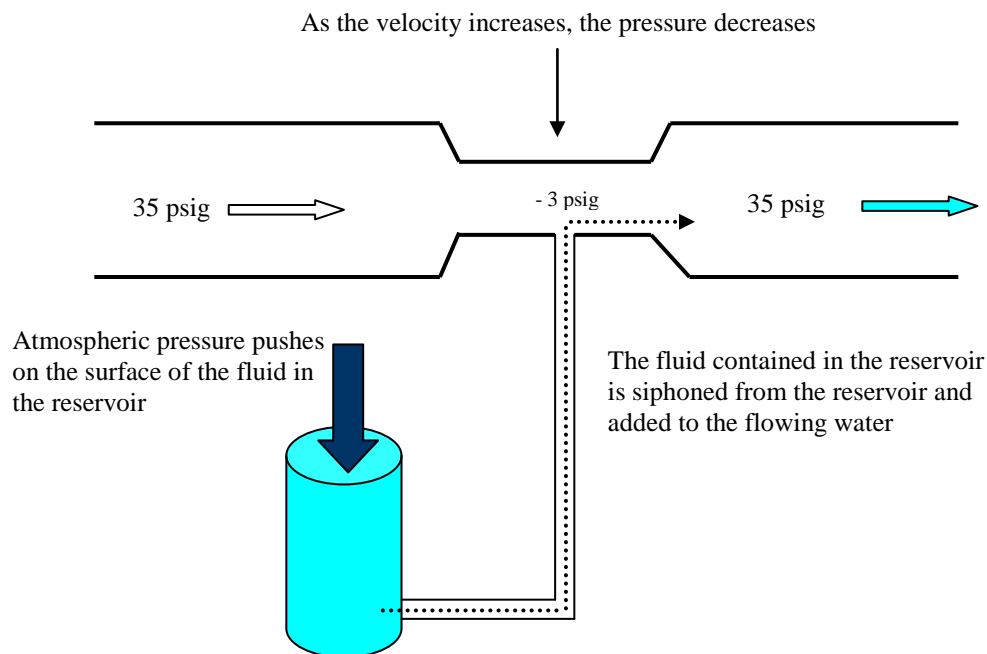

Figure 11

OHIO DEPARTMENT OF COMMERCE BACKFLOW PREVENTION MANUAL

COMMERCIAL VENTURI

A venturi is one of the more common cross-connections that you will encounter in plumbing systems.

A commercial venturi can be found at:

- janitor sinks
- dishwashers
- soap eductors
- wax eductors
- hydro-aspirators
- lawn sprayers
- dental vacuum equipment

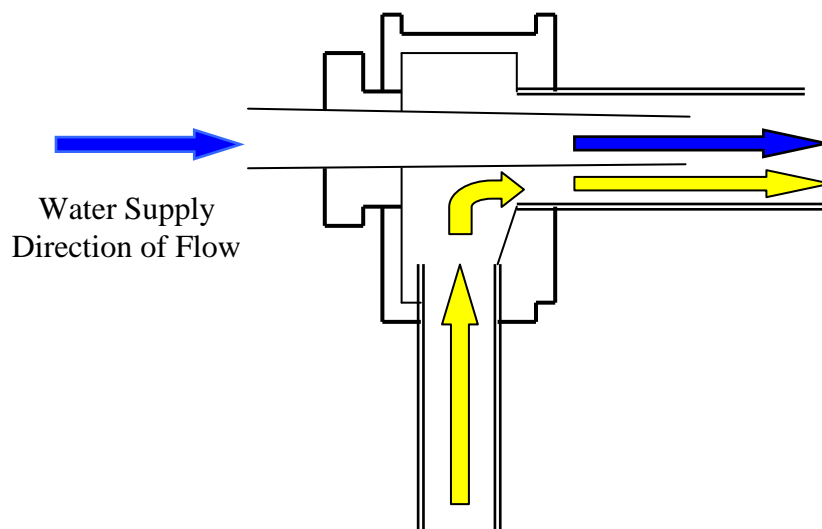

Adds a fluid through a siphon action

Figure 12

OHIO DEPARTMENT OF COMMERCE BACKFLOW PREVENTION MANUAL

APPROVED AIR-GAP SEPARATION

An air-gap separation is a physical separation between the potable water supply outlet piping and a receiving vessel or container. This separation must be an unobstructed vertical distance through the atmosphere.

The vertical separation is determined by the minimum effective diameter of the water supply outlet piping. This distance is usually two times the effective diameter, but not less than one inch. If an outlet is a distance of twice the effective opening from a wall or obstruction, then the air-gap separation must be extended to three times the effective opening. If the outlet is near two intersecting walls, then the separation should be extended to four times the effective opening.

An air-gap separation is the most basic type of backflow preventer. A properly installed air-gap separation eliminates the possibility of a cross-connection, as it creates a physical break between the potable water supply and the potential source of contamination or pollution. However, care should be taken when installing an air-gap in an area where toxic gases are present and may be drawn into the supply piping.

An air-gap separation must be inspected at least every twelve months just like any other method of mechanical backflow prevention.

It is critical that the air-gap not be defeated through the addition of a hose or extended piping. It should be noted that once potable water leaves the distribution system, the system pressure within the receiving vessel becomes atmospheric or zero (0 psig). The user may find it necessary to install a pump to re-pressurize a plumbing system downstream of the tank.

Consult ANSI Standard A112.1.2, "Air-Gaps in Plumbing Systems" for more information.

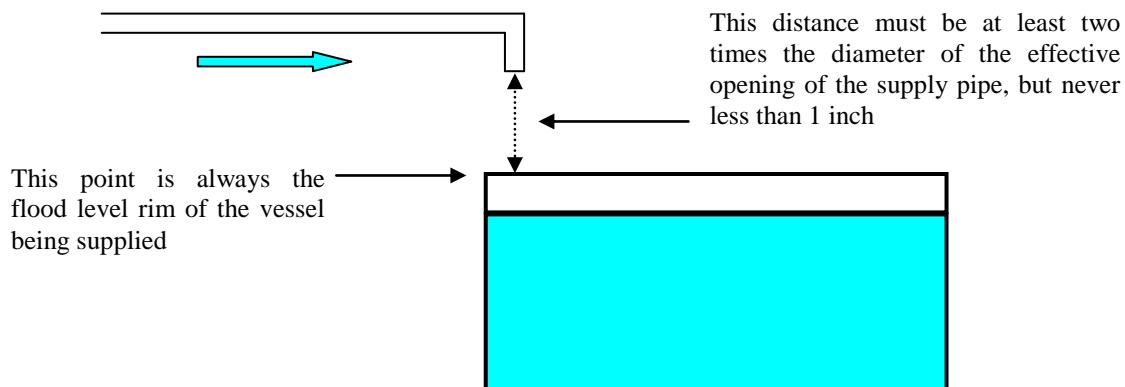

Figure 13

OHIO DEPARTMENT OF COMMERCE BACKFLOW PREVENTION MANUAL

REDUCED PRESSURE PRINCIPLE BACKFLOW PREVENTER

This backflow preventer is an assembly of several components. It has inlet and outlet shut-off valves and four appropriately located test cocks to test its operation. Two check valves are located between the shut-off valves that are spring loaded to a normally closed position and a differential pressure relief valve is located between the check valves. The relief valve is spring loaded to a normally open position so a constant discharge of water indicates a malfunction within the assembly.

These assemblies must be installed where they are not subject to flooding, may not be installed in a pit and an air-gap separation must be maintained at the relief valve discharge port.

The assembly may be used under continuous pressure, and is effective against either backpressure or backsiphonage. This assembly is designed to be used as protection against a high hazard; but may be used on low hazard applications as well. It must be tested at the time of installation and at least every twelve months thereafter. An occasional discharge of water from the relief valve port usually indicates that the device is operating properly.

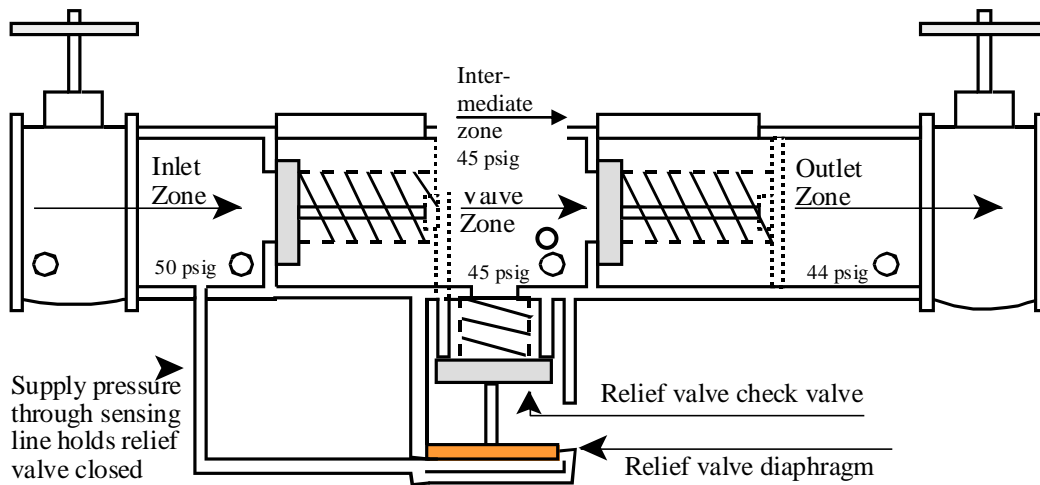

○ = test cocks

TEST POINT	MINIMUM TEST REQUIREMENT
Check valve number 1	To pass the test it must create a loss equal to or greater than the relief valve opening point plus 3 psig
Differential pressure relief valve	The relief valve must vent water before the pressure in the intermediate zone comes within a minimum 2 psig of the supply pressure
Check valve number 2	Must hold tightly against reverse flow (backpressure)
Shut-off valve number 2	Must be drip-tight

Figure 14

OHIO DEPARTMENT OF COMMERCE BACKFLOW PREVENTION MANUAL

DOUBLE CHECK VALVE ASSEMBLY

This assembly of components consists of an inlet and outlet shut-off valves, four appropriately located test cocks to test its operation without removal from the piping, and two independently-acting check valves that are force loaded to a normally closed position. This means that both check valves will be closed when there is no downstream water demand. If the assembly does not contain all of the components described above, then it is not an approved assembly.

The assembly may be used under continuous pressure, and is effective against either backpressure or backsiphonage.

This assembly may be used only where there is only a low hazard potential to the potable water supply. If both check valves should fail, it is then possible for a contaminant to backflow into the potable water supply.

The primary limitation of this device is that there is no visible means to indicate a failure. If either or both check valves fail then the failure will not be discovered until the device is tested. It must be tested at the time of installation and at least every twelve months thereafter.

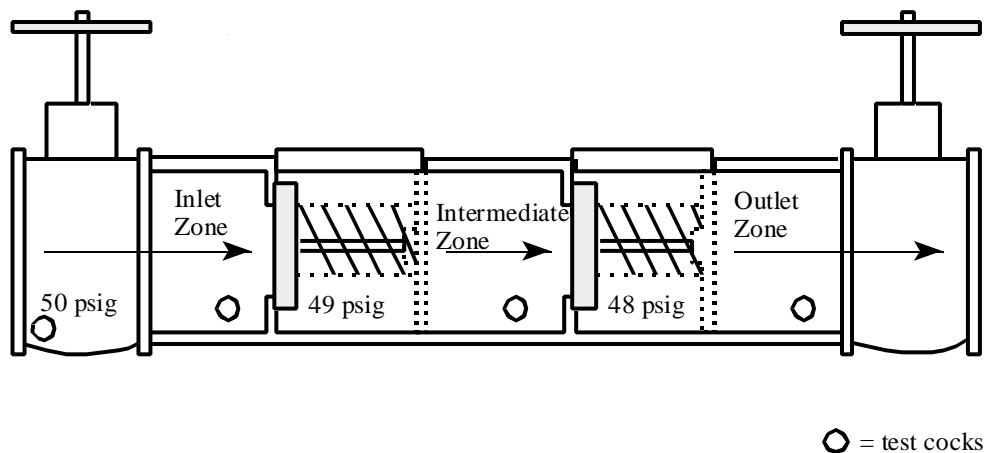

1. Under flow conditions, both checks should be open.
2. Under no flow conditions, both checks should close tightly.
3. Under backpressure or backsiphonage conditions, both checks should close tightly.

TEST POINT	MINIMUM TEST REQUIREMENT
Check valve number 1	Must create a minimum 1 psig pressure loss
Check valve number 2	Must create a minimum 1 psig pressure loss
Shutoff valve number 2	Must be drip-tight

Figure 15

OHIO DEPARTMENT OF COMMERCE BACKFLOW PREVENTION MANUAL

ATMOSPHERIC VACUUM BREAKER

A common characteristic of any vacuum breaker is that this device is designed to prevent only one type of backflow – backsiphonage. The AVB design consists of a combination check valve and air-inlet valve that admits atmosphere into the downstream piping. When the atmospheric air is admitted, it breaks the vacuum to prevent the backsiphonage of contaminant or pollutant into the potable water supply.

Although this device may seem simple in design, the installation guidelines must be followed to ensure a proper installation. An atmospheric vacuum breaker:

- Must be installed a minimum of 6” above the highest point of downstream usage or elevated piping (this is called the critical installation level)
- If the critical installation level is not indicated on the atmospheric vacuum breaker then the critical installation level is measured from the base of the body
- Must be installed in an upright position
- Must not be subjected to any type of backpressure
- Must not have a control or shut-off valve installed at the outlet or downstream of the device
- Must not be subjected to continuous pressure or supply pressure for periods longer than 12 hours

These devices should be tested and maintained periodically to ensure their continued operation.

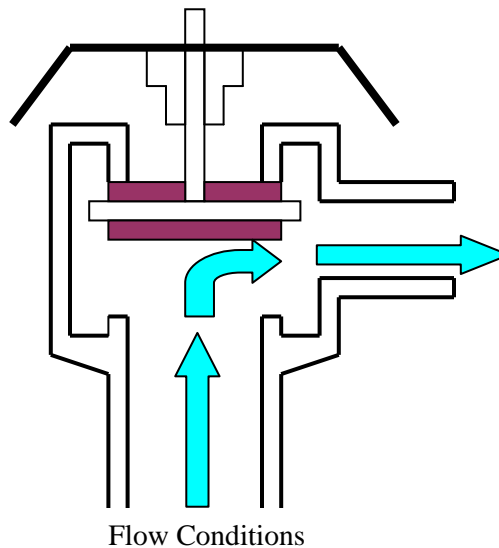

Figure 16

1. There is flow downstream
2. The check valve/air-inlet valve is held closed by the water pressure

**OHIO DEPARTMENT OF COMMERCE
BACKFLOW PREVENTION MANUAL**

ATMOSPHERIC VACUUM BREAKER

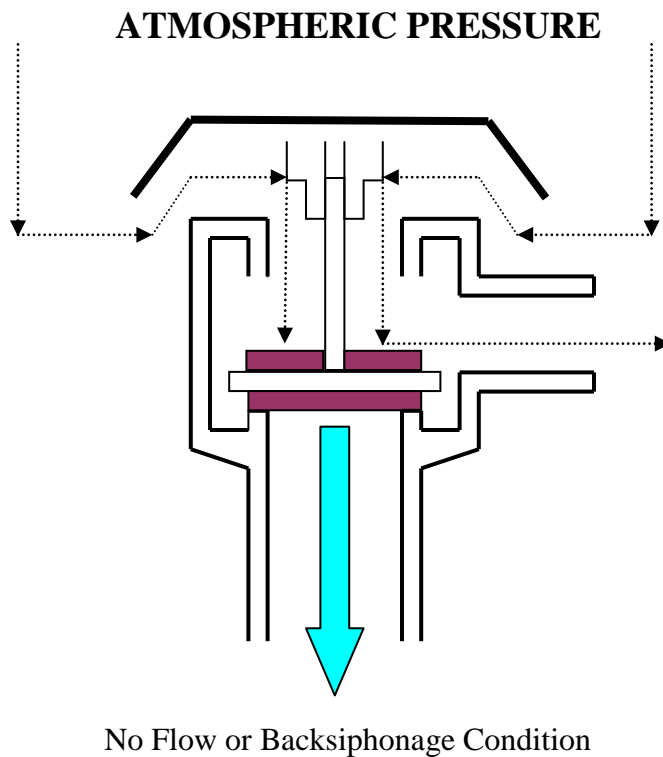

Figure 17

1. There is no flow downstream
2. The check valve/air-inlet valve falls closed due to gravity

OHIO DEPARTMENT OF COMMERCE BACKFLOW PREVENTION MANUAL

PRESSURE VACUUM BREAKER

Pressure vacuum breaker assemblies two-inch and smaller contain inlet and outlet shut-off valves. It has two appropriately located test cocks for testing purposes; a check valve located downstream of the inlet valve that is spring loaded to a normally closed position; and an air inlet valve that is spring loaded to a normally open position.

When water flows through the assembly, the check valve will open and water pressure will close the air inlet valve to keep atmospheric pressure from entering the device.

When there is no flow or a backsiphonage condition, the check valve will close. As the water pressure inside the valve body decreases to the loading or tension of the air inlet valve spring, the valve will open to atmosphere which allows air to enter the downstream plumbing system thereby preventing backsiphonage.

The critical installation level is at least twelve inches above the highest point of downstream use or piping. This is an important operational limitation of this assembly.

This vacuum breaker is called a “pressure” vacuum breaker because it will operate under continuous pressure conditions.

The installation guidelines must be followed to ensure a proper installation. A pressure vacuum breaker:

- Must be installed a minimum of 12” above the highest point of downstream usage or elevated piping (this is called the critical installation level)
- If the critical installation level is not indicated on the atmospheric vacuum breaker then the critical installation level is measured from the base of the body
- Must be installed in an upright position
- Must not be subjected to any type of backpressure
- May have a control or shut-off valve installed downstream of the device
- May be subjected to continuous pressure

**OHIO DEPARTMENT OF COMMERCE
BACKFLOW PREVENTION MANUAL**

PRESSURE VACUUM BREAKER

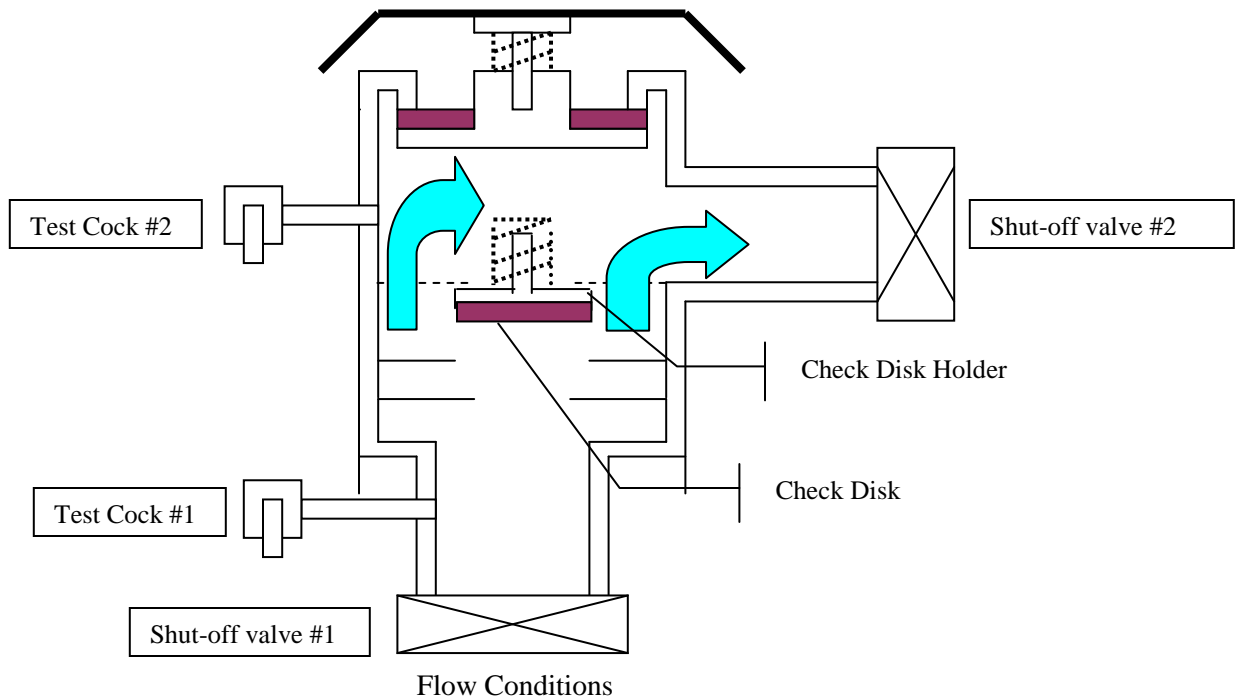
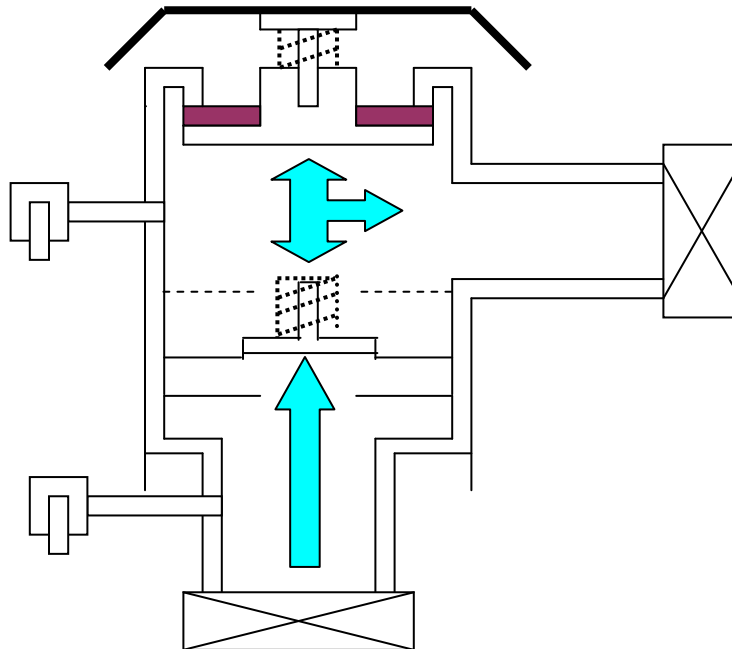

Figure 18

1. There is flow downstream
2. The spring-loaded check valve is held open by the water pressure
3. The spring-loaded air-inlet valve is held closed by the water pressure

**OHIO DEPARTMENT OF COMMERCE
BACKFLOW PREVENTION MANUAL**

PRESSURE VACUUM BREAKER



No Flow Conditions

Figure 19

1. There is no flow downstream
2. The air-inlet valve is held closed by the water pressure in the body
3. The check valve is pushed closed by the spring

**OHIO DEPARTMENT OF COMMERCE
BACKFLOW PREVENTION MANUAL**

PRESSURE VACUUM BREAKER

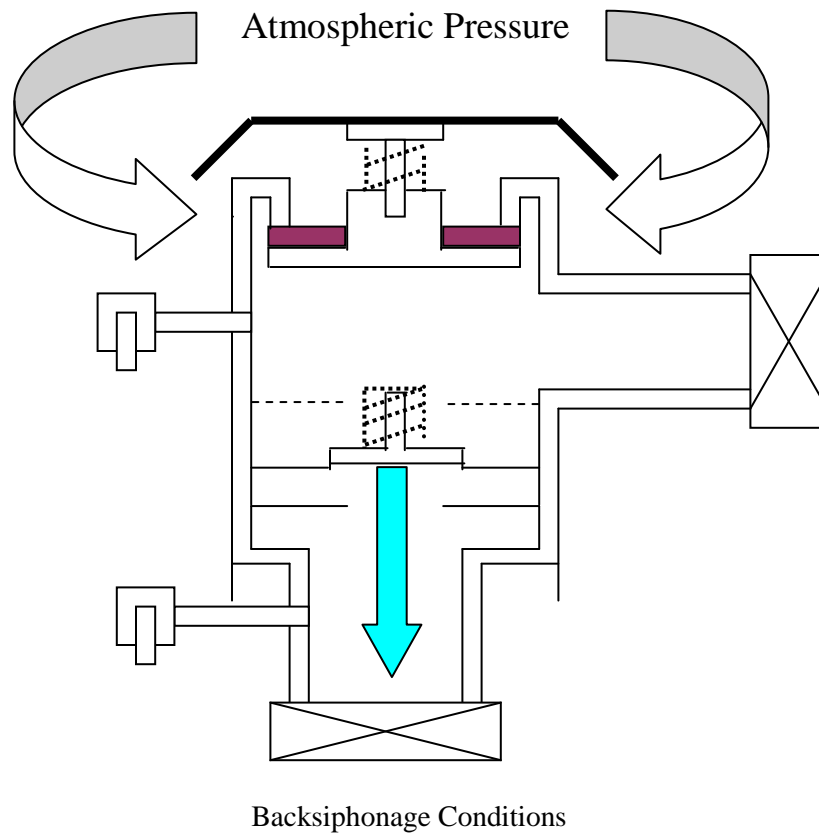

Figure 20

1. There is no flow downstream
2. The check valve is held closed by the spring
3. The air inlet valve will be held closed by the water pressure in the body, unless the check valve fails to hold tightly under backsiphonage conditions at which time the air inlet valve will open

OHIO DEPARTMENT OF COMMERCE BACKFLOW PREVENTION MANUAL

INSTALLATION REQUIREMENTS CONTAINMENT DEVICES

It is your responsibility as the installer to be familiar with the local codes or regulations regarding the proper installation of a containment backflow prevention device. It is recommended that you consult with the water supplier before installing a containment device.

The installation requirements for a containment principle backflow prevention device are normally determined by the local water supplier. The following are a few of the typical requirements.

- a containment device must be approved by the water supplier before installation, most water suppliers accept the devices that meet ASSE, USC, CSA or AWWA standards
- must be installed in a horizontal position
- must be 12” to 36” off of the floor
- test cocks must be facing into the room if they are side-mounted on the device
- must be installed in an area free of noxious fumes (for tester safety)
- must be accessible for inspection, testing and maintenance
- an ASSE 1013 or 1047 may not be installed in a pit (due to the possibility of flooding of the pit)
- you may not make a direct connection to the relief valve on an ASSE 1013 or ASSE 1047
- as ASSE 1015 or 1048 may be installed in a pit if approved by the local water supplier
- you may not install an unprotected bypass around any backflow prevention device (there must be equal protection on the bypass line) A bypass line may also be called a manifold, parallel, dual or tandem setting.

The installation requirements for an isolation principle backflow prevention device are normally determined by the Ohio plumbing code and the local plumbing inspection authorities.

Since there are few rules regarding the installation of isolation principle devices and if there are no requirements by the local Plumbing Authorities, the Plumbing Unit of the Ohio Department of Commerce suggests that you install an isolation device in accordance with the manufacturer's recommendations.

It is in your best interest to be familiar with the installation requirements because you can eliminate unnecessary return trips to correct an improper installation.

If you are unsure of the local requirements, then you should contact the water supplier or plumbing inspection authority for direction before you install the device.

OHIO DEPARTMENT OF COMMERCE BACKFLOW PREVENTION MANUAL

BACKFLOW PREVENTER APPLICATION

ASSEMBLIES INSTALLED AS CONTAINMENT PROTECTION

The Ohio EPA recognizes only four types of backflow prevention assemblies for use as a containment principle protection, the double check valve assembly, the reduced pressure principle backflow preventer, the double check detector check assembly and the reduced pressure detector check assembly.

Additionally, the Ohio EPA recognizes a properly installed pressure vacuum breaker as acceptable backflow prevention protection for a residential irrigation system that has no pumps or additives.

DEVICES INSTALLED AS ISOLATION PROTECTION

The Ohio Department of Commerce, Industrial Compliance Division recognizes those backflow prevention devices that have obtained the American Society of Sanitary Engineering (ASSE) seal authorization approval for use as an isolation principle backflow prevention protection.

The ASSE Standard Number will be stamped into the body of the device or printed on a metal plate that is attached to the device.

The ASSE seal authorization approval list may be viewed at www.asse-plumbing.org.

In order to select the appropriate backflow prevention device for an application, it is necessary that you understand the appropriate application and the limitations of the various devices.

The following informational charts indicate the available devices and their application.

OHIO DEPARTMENT OF COMMERCE BACKFLOW PREVENTION MANUAL

BACKFLOW PREVENTION DEVICES

Pipe Applied Atmospheric Vacuum Breaker

Standard Number: ASSE 1001
Protection Provided: Backsiphonage Only
Hazard Level: High or Low Hazard
Limitation: May not be used under continuous pressure conditions
Must be installed at least 6" above the highest downstream use
May not have a downstream shut-off valve
Construction: A combination check valve / air inlet valve

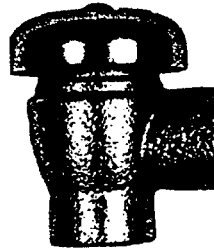
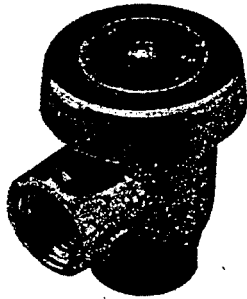

Anti-Siphon Fill Valve (Ballcock) for Water Closet Flush Tank

Standard Number: ASSE 1002
Protection Provided: Backsiphonage Only
Hazard Level: High or Low Hazard
Limitation:
Construction: Float operated anti-siphon toilet ballcock

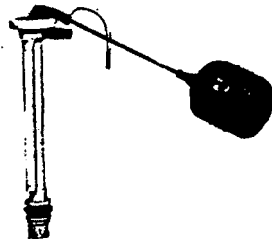

OHIO DEPARTMENT OF COMMERCE BACKFLOW PREVENTION MANUAL

BACKFLOW PREVENTION DEVICES

Hose Connection Vacuum Breaker

Standard Number: ASSE 1011
Protection Provided: Backsiphonage and Low Head Backpressure
Hazard Level: High or Low Hazard
Limitation: May not be used under continuous pressure conditions
Construction: A single check valve & an atmospheric vent valve

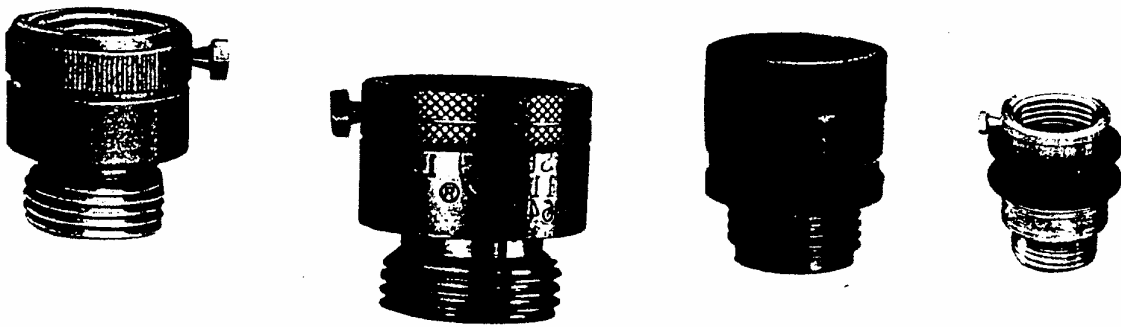

Backflow Preventer with Intermediate Atmospheric Vent

Standard Number: ASSE 1012
Protection Provided: Backsiphonage and Backpressure
Hazard Level: Low Hazard Only
Limitation: Low pressure only
Vent on device to be in down position with approved air-gap separation at the vent
Construction: Two independently operating check valves with a vent between the check valves that opens to atmosphere

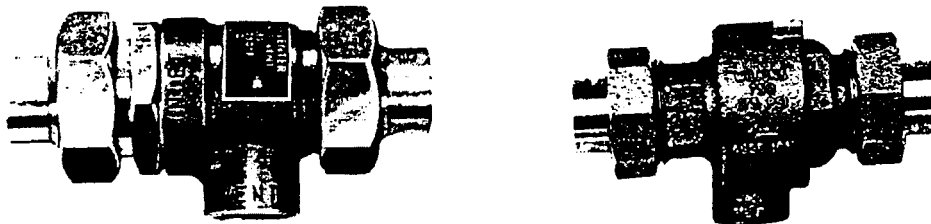

OHIO DEPARTMENT OF COMMERCE BACKFLOW PREVENTION MANUAL

BACKFLOW PREVENTION DEVICES

Reduced Pressure Principle Backflow Preventer

Standard Number: ASSE 1013
Protection Provided: Backsiphonage and Backpressure
Hazard Level: High or Low Hazard
Limitation: May not be installed in a pit
Must maintain an approved air-gap separation at the relief valve vent port
Construction: Two independently-acting check valves, a hydraulic relief valve between the check valves, tightly closing inlet & outlet valves, four appropriately located test cocks

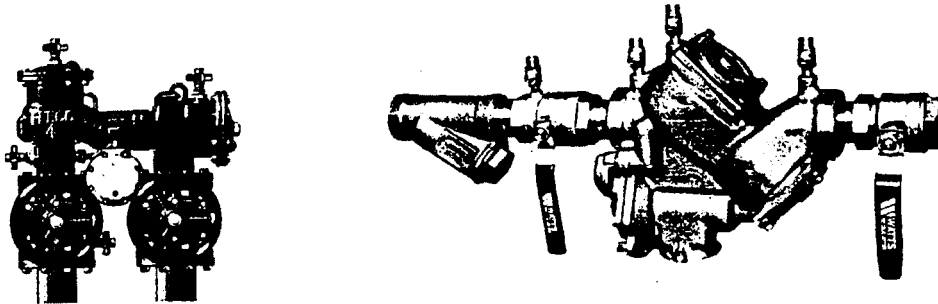

Reduced Pressure Principle Detector Check Assembly

Standard Number: ASSE 1047
Protection Provided: Backsiphonage and Backpressure
Hazard Level: High or Low Hazard
Limitation: Used for fire protection systems containing any additive or a connection to stored water or an auxiliary water source
May not be installed in a pit
Construction: Two reduced pressure assemblies installed in parallel, four test cocks on each assembly, and a bypass meter to detect low water flow usage

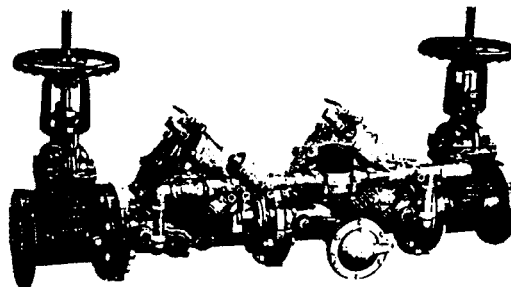

OHIO DEPARTMENT OF COMMERCE BACKFLOW PREVENTION MANUAL

BACKFLOW PREVENTION DEVICES

Double Check Backflow Prevention Assembly

Standard Number: ASSE 1015
Protection Provided: Backsiphonage and Backpressure
Hazard Level: Low Hazard Only
Limitation:
Construction: Two independently-acting check valves, tightly closing inlet & outlet valves, and four appropriately located test cocks

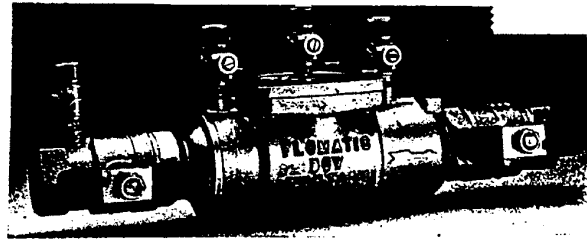
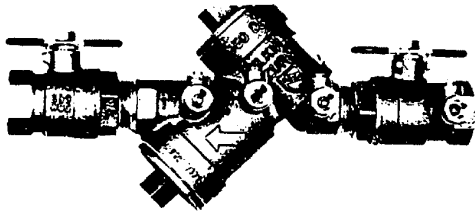

Double Check Detector Check Assembly

Standard Number: ASSE 1048
Protection Provided: Backsiphonage and Backpressure
Hazard Level: Low Hazard Only
Limitation: Used for fire protection systems containing no additives, storage or auxiliary water connection
Construction: Two double check valve assemblies installed in parallel, four test cocks on each assembly, and a bypass meter to detect low water flow usage

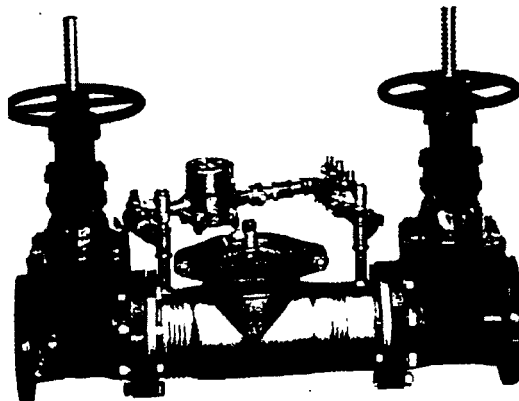

OHIO DEPARTMENT OF COMMERCE BACKFLOW PREVENTION MANUAL

BACKFLOW PREVENTION DEVICES

Vacuum Breaker Wall Hydrant, Freeze Resistant, Automatic Draining Type

Standard Number: ASSE 1019
Protection Provided: Backsiphonage and Low Head Backpressure
Hazard Level: High or Low Hazard
Limitation: May not be used under continuous pressure conditions
Construction: A wall hydrant with an internal vent valve and a means to drain the barrel to prevent freezing

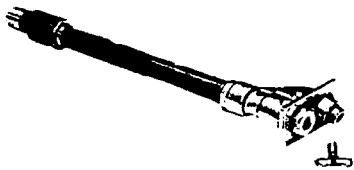

Pressure Vacuum Breaker Assembly

Standard Number: ASSE 1020
Protection Provided: Backsiphonage Only
Hazard Level: High or Low Hazard
Limitation: The critical installation level is 12" above the highest downstream use
Construction: A spring-loaded check valve and an independently-acting, spring-loaded air inlet valve, and tightly closing inlet & outlet valves

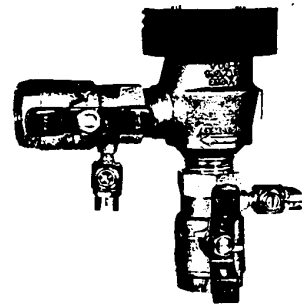
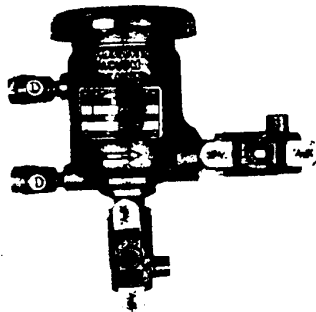
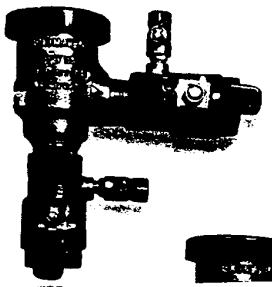

OHIO DEPARTMENT OF COMMERCE BACKFLOW PREVENTION MANUAL

BACKFLOW PREVENTION DEVICES

Backflow Preventer for Carbonated Beverage Machine

Standard Number: ASSE 1022
Protection Provided: Backsiphonage and Backpressure
Hazard Level: Low Hazard Only, Required on the potable water supply line to Post-Mix Carbonated Beverage Dispensers
Limitation:
Construction: Two independently acting check valves with a vent to atmosphere

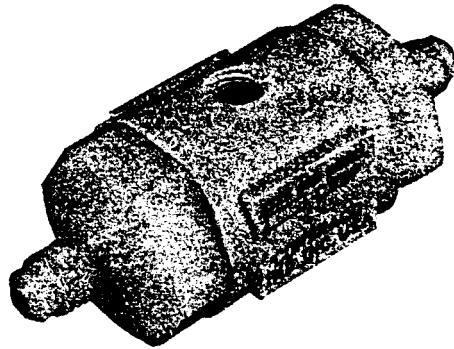
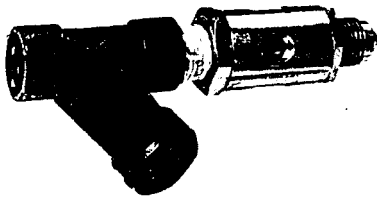

Dual Check Valve Type Backflow Preventer

Standard Number: ASSE 1024
Protection Provided: Backsiphonage and Backpressure
Hazard Level: Low Hazard Only
Limitation:
Construction: Two independently acting check valves



OHIO DEPARTMENT OF COMMERCE BACKFLOW PREVENTION MANUAL

BACKFLOW PREVENTION DEVICES

Dual Check Valve Type Backflow Preventer for Post Mix Carbonated Beverage Dispensers

Standard Number: ASSE 1032
Protection Provided: Backsiphonage and Backpressure
Hazard Level: Low Hazard Only
Limitation:
Construction: Two independently acting check valves, usually found inside the dispenser

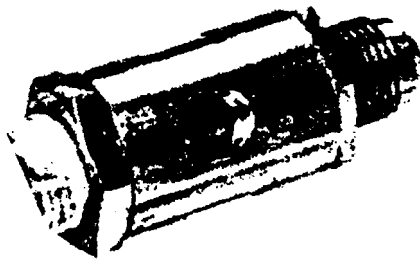

Laboratory Faucet Backflow Preventer, Vacuum Breaker

Standard Number: ASSE 1035
Protection Provided: Backsiphonage and Low Head Backpressure
Hazard Level: High or Low Hazard
Limitation: May not be used under continuous pressure conditions
Construction: Two independently acting check valves with a means to vent to atmosphere under backsiphonage conditions

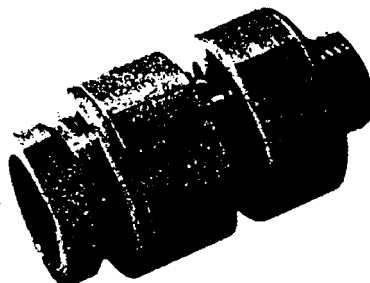

OHIO DEPARTMENT OF COMMERCE BACKFLOW PREVENTION MANUAL

BACKFLOW PREVENTION DEVICES

Hose Connection Backflow Preventer, Vacuum Breaker

Standard Number: ASSE 1052
Protection Provided: Backsiphonage and Low Head Backpressure
Hazard Level: High or Low Hazard
Limitation: May not be used under continuous pressure conditions
Construction: Two independently acting check valves with an intermediate vent to the atmosphere

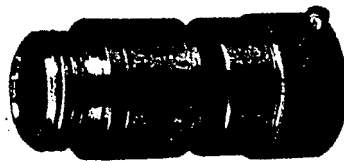

Backsiphonage Vacuum Breaker, Spill-Proof

Standard Number: ASSE 1056
Protection Provided: Backsiphonage Only
Hazard Level: High or Low Hazard
Limitation: The critical installation level is 6" above the highest downstream use or 1" when equipment mounted
Construction: At least one check valve and an automatic vent valve to atmosphere, tightly closing inlet & outlet valves, and a test cock



OHIO DEPARTMENT OF COMMERCE BACKFLOW PREVENTION MANUAL

BACKFLOW PREVENTION DEVICES

Air-Gap Separation

Standard Number: ANSI A112.1.2
Protection Provided: Backsiphonage and Backpressure
Hazard Level: High or Low Hazard
Limitation: Must be at least two times the nominal diameter of the discharge piping but never less than one inch
Construction: A physical separation through the free atmosphere measured from the opening of the discharge piping to the flood level rim of the receiving vessel

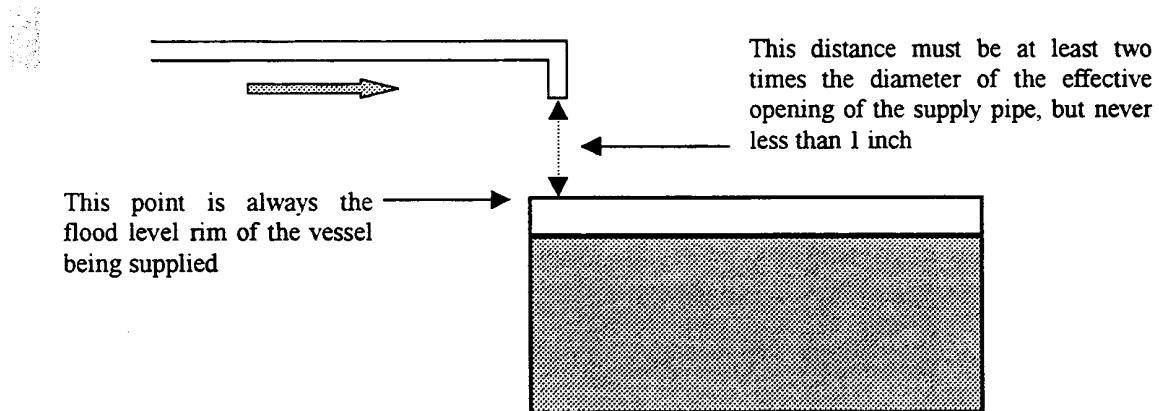

BACKFLOW PREVENTION APPLICATION CHART

DEVICE	ASSE NO.	HAZARD LEVEL	PROTECTION PROVIDED
Air Gap Separation	ANSI A112.1	Severe High, High or Low Hazard	Backsiphonage / Backpressure
Pipe Applied Atmospheric Type Vacuum Breaker	ASSE 1001 1/4" - 4"	High or Low Hazard	Backsiphonage Only No continuous pressure
Anti-siphon Fill Valve (Ballcock) for Water Closet Flush Tank	ASSE 1002	High or Low Hazard	Backsiphonage Only
Hose Connection Vacuum Breaker	ASSE 1011 1/2", 3/4", 1"	High or Low Hazard	Backsiphonage Low Head Backpressure No continuous pressure
Backflow Preventer with Intermediate Atmospheric Vent	ASSE 1012 1/4" - 3/4"	Low Hazard Low Pressure	Backsiphonage / Backpressure
Reduced Pressure Principle Backflow Preventer	ASSE 1013 3/8" - 10"	High or Low Hazard	Backsiphonage / Backpressure
Reduced Pressure Principle Detector Check Assembly	ASSE 1047 1 1/2" - 10"	High or Low Hazard fire sprinkler systems	Backsiphonage / Backpressure
Double Check Backflow Prevention Assembly	ASSE 1015 3/8" - 10"	Low Hazard Only	Backsiphonage / Backpressure
Double Check Detector Check Assembly	ASSE 1048 1 1/2" - 10"	Low Hazard Only fire sprinkler systems	Backsiphonage / Backpressure
Vacuum Breaker Wall Hydrant, Freeze-Resistant, Automatic Draining Type	ASSE 1019 3/4" & 1"	High or Low Hazard	Backsiphonage Low Head Backpressure No continuous pressure
Pressure Vacuum Breaker Assembly	ASSE 1020 1/2" - 2"	High or Low Hazard	Backsiphonage Only
Backflow Preventer for Carbonated Beverage Machine	ASSE 1022 1/4" - 3/8"	Low Hazard Only	Backsiphonage / Backpressure
Dual Check Valve Type Backflow Preventer	ASSE 1024 Sizes 1/4" - 1"	Low Hazard Only	Backsiphonage / Backpressure
Dual Check Valve Type Backflow Preventer for Post-Mix Beverage Dispenser	ASSE 1032 1/4" - 3/8"	Low Hazard Only	Backsiphonage / Backpressure
Laboratory Faucet Backflow Preventer, Vacuum Breaker	ASSE 1035 3/8"	High or Low Hazard	Backsiphonage Low Head Backpressure No continuous pressure
Hose Connection Backflow Preventer, Vacuum Breaker	ASSE 1052 1/2" - 1"	High or Low Hazard	Backsiphonage Low Head Backpressure
Backsiphonage Vacuum Breaker, Spill-Proof	ASSE 1056 1/8" - 2"	High or Low Hazard	Backsiphonage Only

BACKFLOW PREVENTION APPLICATION CHART

INSTALLATION	EXAMPLES OF INSTALLATION
Should be used whenever possible, is the only absolute means of preventing backflow	Lavatories, process tanks, sinks, bathtubs, and cooling towers
May not have a downstream valve since this device is not designed to operate under continuous pressure	Irrigation systems, process tanks, dishwashers, and soap dispensers
Tank type water closet or flush tank for urinals	Gravity fill water closet or flush tank type urinals
Low head backpressure is intended to mean negligible backpressure in the 1.0 psi to 2.0 psi range, no continuous pressure over 12 hrs	Hose bib connections
Low hazard cross-connections under continuous pressure, but may not be subject to high-pressure backpressure	Low-pressure boilers or cooling towers containing no additives
Cross-connections subject to backsiphonage or backpressure and operating under continuous pressure	Main supply lines, commercial or chemically treated boilers or chillers, main hospital lines and equipment, tanks with submerged inlets
Installed on a fire protection system containing any additive, even a food-grade additive	Chemically charged fire protection systems (such as Foamite), or a fire protection system that contains any additive or anti-freeze
Installed to prevent the backflow of a substance that would not present a hazard to health	Main supply lines, food cookers, tanks or vats containing non-toxic substances
Installed on a fire protection system that contains only the public water, has no booster pump, storage, or auxiliary water	Non-chemically charged and/or non-toxic fire protection systems; a fire sprinkler system that is filled with water from the public water supply
Low head backpressure is intended to mean negligible backpressure in the 1.0 psi to 2.0 psi range, no continuous pressure over 12 hrs.	Wall hydrant hose bib
Continuous pressure is OK because the air-inlet and check valve are spring-loaded	Irrigation systems, plating tanks, livestock watering systems, supply to a submerged inlet
Constructed of non-copper material, must include a strainer	Installed on the water supply line to carbonated beverage dispensers prior to the carbonating point, no copper beyond this device
Low hazard cross-connections, continuous pressure, backsiphonage and backpressure	Residential water service connections, individual outlets
Independently-acting check valves	Installed inside the post-mix type carbonated beverage dispensers, by the beverage maintenance personnel
Low head backpressure is intended to mean negligible backpressure in the 1.0 psi to 2.0 psi range, no continuous pressure over 12 hrs	Laboratory faucets
Low head backpressure is intended to mean negligible backpressure in the 1.0 psi to 2.0 psi range, no continuous pressure over 12 hrs	Hose bib connections
Used in areas where water spillage may present a problem	X-ray or photo developing machines

OHIO DEPARTMENT OF COMMERCE BACKFLOW PREVENTION MANUAL

APPLICATION CHART

You will have to understand and memorize the information on the backflow prevention application chart to properly utilize the protection provided by the various types of devices.

The following **Memory Shortcuts** may help you to remember the information on the chart.

Assume that all backflow prevention devices operate under the these conditions

Backpressure	Backsiphonage
High Hazard	Low Hazard

Any backflow prevention device with the word dual or double in its name is not acceptable as protection against a high hazard

Backpressure	Backsiphonage
	Low Hazard

Any backflow prevention device with the word vacuum in its name is not acceptable as protection against backpressure

	Backsiphonage
High Hazard	Low Hazard

You can remember the appropriate critical installation level for a vacuum breaker by using this chart. "A" comes before "P" alphabetically and "6" comes before "12" numerically.

Atmospheric 1001	Pressure 1020
6"	12"

Keep in mind that some terms are used interchangeably and imply the same condition.

Pollution = Low Hazard = Non-Toxic
Contaminant = High Hazard = Toxic

OHIO DEPARTMENT OF COMMERCE BACKFLOW PREVENTION MANUAL

THERMAL EXPANSION CONTROL

The Ohio Basic Building Code, Plumbing; Section 607, “Hot Water Supply System”, Sub-Section 607.3.2, “Backflow Prevention Device or Check Valve” specifies that:

“Where a backflow prevention device, check valve, or other device is installed on a water supply system utilizing storage water heating equipment such that thermal expansion causes an increase in pressure, a device for controlling pressure shall be installed.”

Thermal expansion of heated water will occur wherever potable water is heated in a closed system. Uncontrolled thermal expansion usually results in leaking faucets or burst washing machine supply hoses, but may result in the collapse of the vent pipe on gas-fired water heaters, or violently burst water heaters in extreme cases.

An expansion tank is one method (others methods are available refer to plumbing code) designed to absorb thermal expansion that will be created by the hot water heater, if the water user’s potable system is closed with a containment principle backflow prevention assembly, a check valve or a pressure reducing valve without an internal bypass.

The expansion tank must be installed in the cold water service piping on the supply side of the hot water heater prior to any control valves. The size of the expansion tank is based upon the size of the hot water heater and may be determined by referring to the manufacturer recommendations.

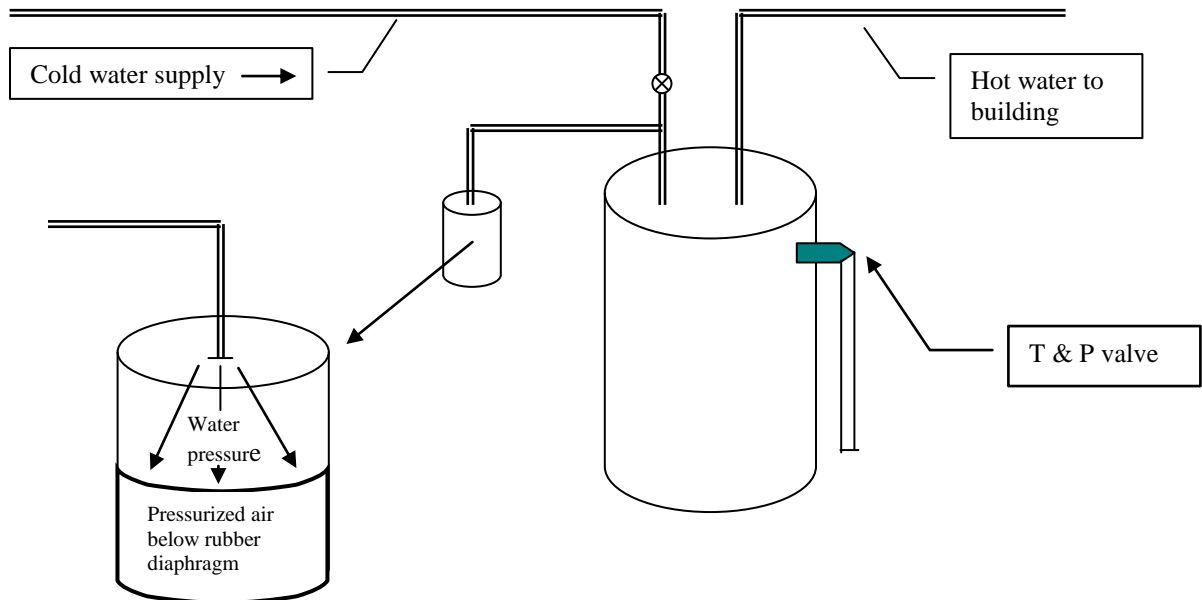

Figure 21

OHIO DEPARTMENT OF COMMERCE BACKFLOW PREVENTION MANUAL

BAROMETRIC LOOP

A barometric loop is a backflow prevention method that may be used as a protection only against backsiphonage. The critical installation level of a barometric loop is 35' above the flood level rim of the highest downstream fixture being supplied. Since atmospheric pressure will elevate water to a height of only 34 feet (14.7 psig X 2.31), then the 35' loop prevents a backsiphonage from occurring.

A barometric loop is not effective against backpressure but is effective against a low or high hazard and is usually installed on a single process line within the consumer's distribution system.

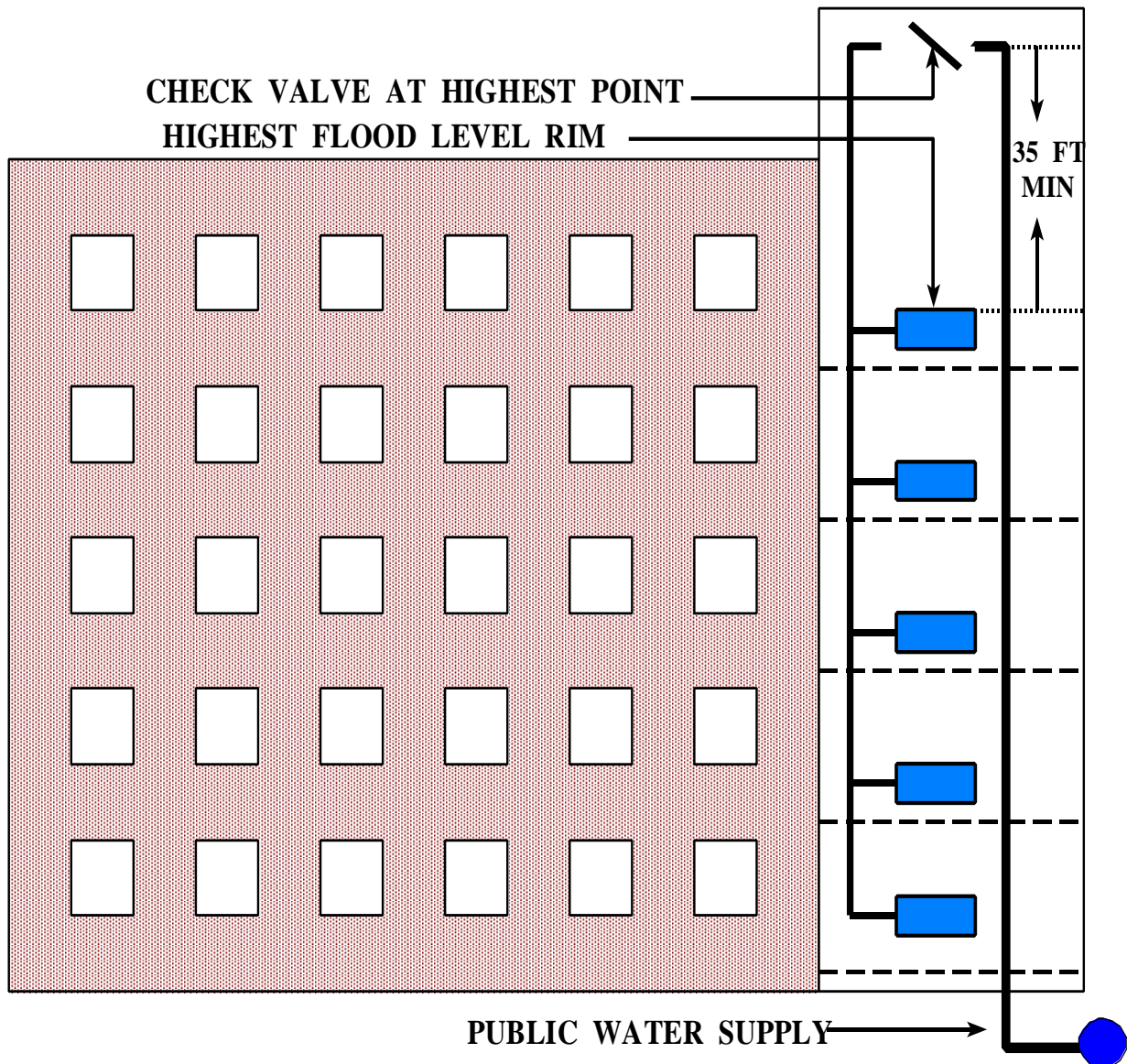

Figure 22

OHIO DEPARTMENT OF COMMERCE BACKFLOW PREVENTION MANUAL

AUXILIARY WATER SOURCES

An auxiliary water system is any water system on or available to the premises other than the public water system. These auxiliary water systems shall include used water or water from a source other than the public water system, such as wells, cisterns or open reservoirs that are equipped with pumps or other prime movers, including gravity.

An auxiliary water source may only be interconnected with the consumer's piping provided it meets the Ohio EPA requirements and is approved by the water supplier and the Ohio Environmental Protection Agency.

An interchangeable connector is the only approved means to interconnect a consumer's auxiliary water source with the piping connected to the public water system. The consumer's water piping and an auxiliary water source may be interconnected only in an industrial setting and provided it is approved by the Ohio EPA (this is the exception to the general rule that the Ohio EPA has no authority inside the building).

If the use of an interchangeable connector is approved, then an approved containment principle reduced pressure backflow preventer must be installed at the water meter and on the leg prior to the interchangeable connector that is supplying water from the consumer's water distribution system. See page 53 for drawings on installation requirements.

In a residential setting the public water service shall not be interconnected with an auxiliary water source under any condition.

It must be noted that any premises that has an auxiliary water source on or available to the premises must have a containment reduced pressure principle backflow prevention assembly installed at the water meter even though there is no intent to interconnect the two sources. This requirement is due to the potential for the two sources to be inadvertently interconnected in the future.

OHIO DEPARTMENT OF COMMERCE BACKFLOW PREVENTION MANUAL

INTERCHANGEABLE CONNECTOR

There are two types of interchangeable connectors.

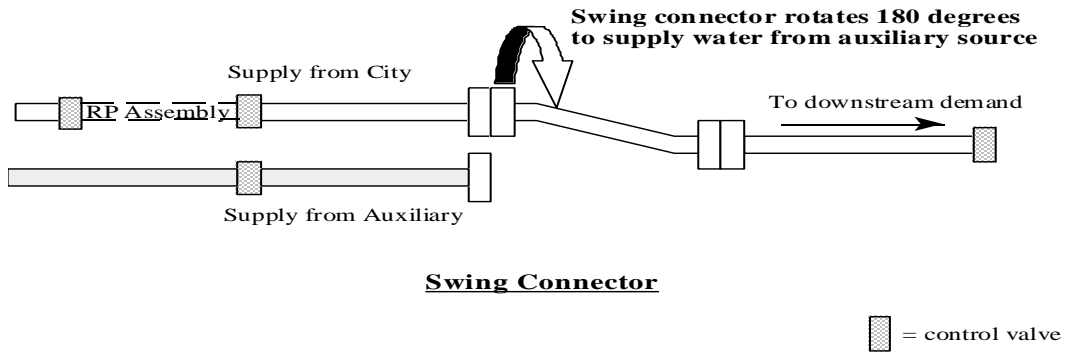
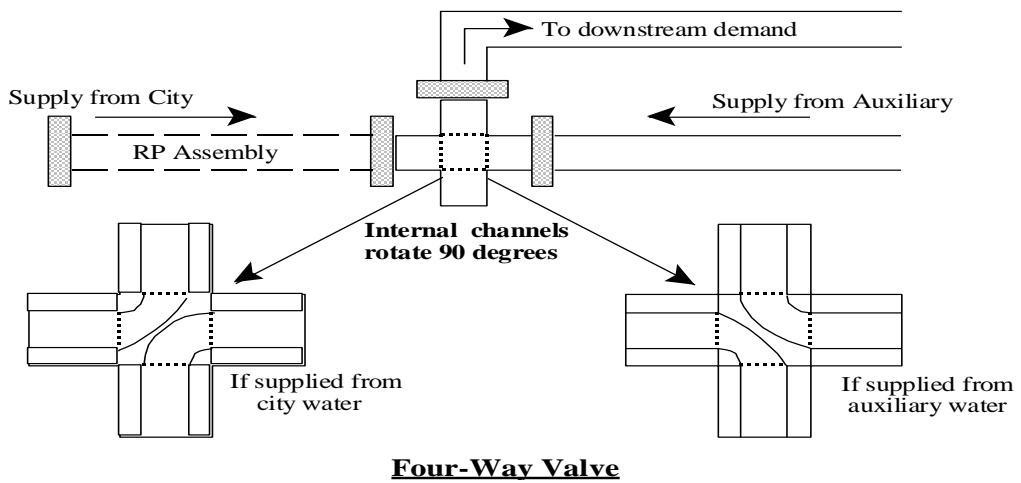

Figure 23



Four-Way Valve
The drain port on the four way valve shall not be installed in the vertical position

Figure 24

Diagrams from the Ohio EPA Manual

OHIO DEPARTMENT OF COMMERCE BACKFLOW PREVENTION MANUAL

LOW-SUCTION PRESSURE CUT-OFF CONTROLLER

The Ohio Environmental Protection Agency and the Ohio Department of Commerce require that a low-suction pressure cut-off controller must be installed on any domestic water booster pump that takes direct suction from the public water system. This applies to potable water pumps not intended for fire suppression.

A low-suction pressure cut-off controller (LPS) is intended to shut-off a booster pump, if the pressure on the suction-side of that booster pump drops to 10 psig. There is a thirty second delay after the pressure drops to 10 psig, and the LPS will shut-down the booster pump if the suction-side pressure remains at 10 psig for that entire thirty second period.

It is an electronic controller that senses the supply pressure to the booster pump via a piped connection at the suction-side of the booster pump. It is wired to the booster pump controller. If the pressure on the suction-side of the pump drops to 10 psig, there is a prescribed set of audible and visual indicators on the LPS controller indicating that a low-suction pressure condition exists.

Most booster pump manufacturers now include the low-suction cut-off controller as an integral part of the pump controller. The stand alone cut-off controller as shown in the illustration will be necessary only on a retrofit of an existing booster pump. These controllers must be tested at the time of installation and every twelve months thereafter.

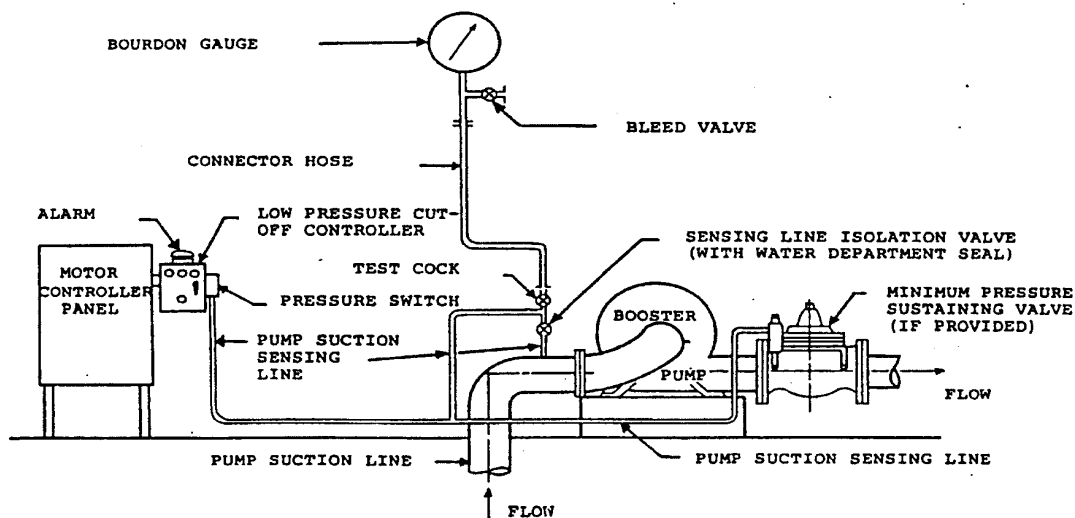

Figure 25

Illustration from Ohio EPA Manual

OHIO BASIC BUILDING CODE PLUMBING

SECTION 608 PROTECTION OF POTABLE WATER SUPPLY

608.1 General

A potable water supply system shall be designed, installed and maintained in such a manner as to prevent contamination from non-potable liquids, solids or gases from being introduced into the potable water supply through cross-connections or any other piping connections to the system. Backflow preventer applications shall conform to Table 608.1, except as specifically stated in Sections 608.2 through 608.16.10.

608.2 Plumbing Fixtures

The supply lines or fitting for every plumbing fixture shall be installed so as to prevent backflow. Plumbing fixtures shall provide backflow protection in accordance with ASME A112.18.1.

608.3 Devices, Appurtenances, Appliances, Apparatus

All devices, appurtenances, appliances and apparatus intended to serve some special function, such as sterilization, distillation, processing, cooling, storage of ice or foods, and that connect to the water supply system, shall be provided with protection against backflow and contamination of the water supply system. Water pumps, filters, softeners, tanks and all other appliances and devices that handle or treat potable water shall be protected against contamination.

608.3.1 Special Equipment, Water Supply Protection

The water supply for hospital fixtures shall be protected against backflow with a reduced pressure principle backflow preventer, an atmospheric or spill-proof vacuum breaker or an air-gap. Vacuum breakers for bedpan washer hoses shall not be located less than 5 (1524 mm) feet above the floor. Hose connections in health care or laboratory areas shall not be less than 6 (1829mm) feet above the floor.

608.4 Water Service Piping

Water Service piping shall be protected in accordance with Sections 603.2 and 603.2.1.

608.5 Chemicals and Other Substances

Chemicals and other substances that produce toxic conditions, taste, odor or discoloration in the potable water system, shall not be introduced into, or utilized in, such system.

608.6 Cross-Connection Control

Cross-connections are prohibited except where approved protective devices are installed.

608.6.1 Private Water Supplies

Cross-connections between a private water supply and a potable public supply shall be prohibited.

608.7 Stop-and-Waste Valves Prohibited

Combination stop-and-waste valves or cocks shall not be installed underground.

608.8 Identification of Potable and Non-Potable Water

In all buildings where two or more water distribution systems, one potable water and the other non-potable water, are installed, each system shall be identified by either color marking or metal tags in accordance with Section 608.8.1 through 608.8.3.

608.8.1 Information

Pipe identification shall include the contents of the piping system and an arrow indicating the direction of flow. Hazardous piping systems shall also contain information addressing the nature of the hazard. Pipe identification shall be repeated at maximum intervals of 25 feet. (7620 mm) and at each point where the piping passes through a wall, floor or roof. Lettering shall be readily observable within the room or space the piping is located.

608.8.2 Color

The color of the pipe identification shall be discernible and consistent throughout the building.

608.8.3 Size

The size of the background color field and lettering shall comply with Table 608.8.3

**TABLE 608.8.3
SIZE OF PIPE IDENTIFICATION**

PIPE DIAMETER (inches)	LENGTH OF BACKGROUND COLOR FIELD (inches)	SIZE OF LETTERS (inches)
0.75 to 1.25	8	0.5
1.5 to 2	8	0.75
2.5 to 6	12	1.25
8 to 10	24	2.5
Over 10	32	3.5

For SI: 1inch = 25.4 mm

608.9 Reutilization Prohibited

Water utilized for the cooling of equipment or other processes shall not be returned to the potable water system. Such water shall be discharged into a drainage system through an air-gap or shall be utilized for non-potable purposes.

608.10 Reuse of Piping

Piping that has been used for any purpose other than conveying potable water shall not be utilized for conveying potable water.

608.11 Painting of Water Tanks

The interior surface of a potable water tank shall not be lined, painted or repaired with any material that changes the taste, odor, color or potability of the water supply when the tank is placed into or returned to service.

608.12 Pumps and other appliances

Water pumps, filters, softeners, tanks and all other devices that handle or treat potable water shall be protected against contamination.

608.13 Backflow Protection

Means of protection against backflow shall be provided in accordance with Sections 608.13.1 through 608.13.9.

608.13.1 Air-Gap Separation

The minimum required air-gap shall be measured vertically from the lowest end of a potable water outlet to the flood level rim of the fixture or receptacle into which such potable water outlet discharges. Air gaps shall comply with ASME A112.1.2 and the air gap fitting shall comply with ASME A112.1.3.

608.13.2 Reduced Pressure Principle Backflow Preventer

Reduced pressure principle backflow preventers shall conform to ASSE 1013, AWWA C511, CSA B64.4 or CSA B64.4.1. Reduced pressure detector assembly backflow preventers shall conform to ASSE 1047. These devices shall be permitted to be installed where subject to continuous pressure. The relief opening shall discharge by air gap and shall be prevented from being submerged.

608.13.3 Backflow Preventer with Intermediate Atmospheric Vent

Backflow Preventers with intermediate atmospheric vents shall conform to ASSE 1012 or CSA B64.3. These devices shall be permitted to be installed where subject to continuous pressure conditions. The relief opening shall discharge by air gap and shall be prevented from being submerged.

608.13.4 Barometric Loop

Barometric loops shall precede the point of connection and shall extend vertically to a height of 35 feet (10,688 mm). A barometric loop shall only be utilized as an atmospheric-type or pressure-type vacuum breaker.

608.13.5 Pressure-Type Vacuum Breakers

Pressure-type vacuum breakers shall conform to ASSE 1020 or CSA B64.1.2 and spill-proof vacuum breakers shall comply with ASSE 1056. These devices are designed for installation under continuous pressure conditions when the critical installation level is installed at the required height. Pressure type vacuum breakers shall not be installed in locations where spillage could cause damage to the structure.

608.13.6 Atmospheric-Type Vacuum Breakers

Pipe-applied atmospheric-type vacuum breakers shall conform to ASSE 1001 or CSA B64.1.1. Hose connection vacuum breakers shall conform to ASSE 1011, ASSE 1019, ASSE 1035, ASSE 1052, CSA B64.2, CSA B64.2.1, CSA B64.2.1, CSA B64.2.1.1, CSA B64.2.2 or CSA B64.7. These devices shall operate under normal atmospheric pressure when the critical installation level is installed at the required height.

608.13.7 Double Check Valve Assemblies

Double check valve assemblies shall conform to ASSE 1015, CSA B64.5, CSA B64.5.1 or AWWA C510. Double detector check valve assemblies shall conform to ASSE 1048. These devices shall be capable of operating under continuous pressure.

608.13.8 Spill Proof Vacuum Breakers

Spill proof vacuum breakers (SVB) shall conform to ASSE 1056. These devices are designed for installation under continuous pressure conditions when the critical installation level is installed at the required height.

608.13.9 Chemical Dispenser Backflow Devices

Backflow devices for chemical dispensers shall comply with ASSE 1055 or shall be equipped with an air gap fitting.

608.14 Location of Backflow Preventers

Access shall be provided to backflow preventers as specified by the installation instructions of the approved manufacturer.

608.14.1 Outdoor enclosures for backflow prevention devices

Outdoor enclosures for backflow prevention devices shall comply with ASSE 1060.

608.15 Protection of Potable Water Outlets

All potable water openings and outlets shall be protected against backflow in accordance with Section 608.15.1, 608.15.2, 608.15.3, 608.15.4, 608.15.4.1, 608.15.4.2.

608.15.1 Protection by an air gap

Openings and outlets shall be protected by an air gap between the opening and the fixture flood level rim as specified in Table 608.15.1. Openings and outlets equipped for hose connection shall be protected by means other than an air gap.

**TABLE 608.15.1
MINIMUM REQUIRED AIR GAPS**

FIXTURE	MINIMUM AIR GAP	
	AWAY FROM A WALL (inches)	CLOSE TO A WALL (inches)
Lavatories and other fixtures with effective opening not greater than 0.5 inch in diameter	1	1.5
Sink, laundry trays, gooseneck back faucets and other fixtures with effective openings not greater than 0.75 inch in diameter	1.5	2.5
Over-rim bath fillers and other fixtures with effective openings not greater than 1 inch in diameter	2	3
Drinking water fountains, single orifice not greater than 7/16 inch in diameter or multiple orifices with a total area of 0.150 square inch (area of circle 7/16 inch in diameter)	1	1.5
Effective openings greater than 1 inch	Two times the diameter of the effective opening	Three times the diameter of the effective opening

For SI: 1 inch = 25.4 mm

a. Applicable where walls or obstructions are spaced from the nearest inside-edge of the spout opening a distance greater than three times the diameter of the effective opening for a single wall, or a distance greater than four times the diameter of the effective opening for two intersecting walls.

608.15.2 Protection by a reduced pressure principle backflow preventer

Openings and outlets shall be protected by a reduced pressure principle backflow preventer.

608.15.3 Protection by a backflow preventer with intermediate atmospheric vent

Openings and outlets shall be protected by a backflow preventer with an intermediate atmospheric vent.

608.15.4 Protection by a Vacuum Breaker

Openings and outlets shall be protected by atmospheric-type or pressure-type vacuum breakers. The critical level of the vacuum breaker shall be set a minimum of 6 inches (152 mm) above the flood level rim of the fixture or device. Ball cocks shall be set in accordance with Section 425.3.1. Vacuum Breakers shall not be installed under exhaust hoods or similar locations that will contain toxic fumes or vapors. Pipe-applied vacuum breakers shall be installed not less than 6 inches (152 mm) above the flood level rim of the fixture, receptor or device served.

608.15.4.1 Deck Mounted and Integral Vacuum Breakers

Approved deck mounted or equipment mounted vacuum breakers and faucets with integral atmospheric or spill-proof vacuum breakers shall be installed in accordance with the manufacturer's instructions and the requirements for labeling with the critical installation level not less than 1 inch (25 mm) above the flood level rim.

608.15.4.2 Hose Connections

Sillcocks, hose bibbs, wall hydrants and other openings with a hose connection shall be protected by an atmospheric type or pressure type vacuum breaker or a permanently attached hose connection vacuum breaker.

Exceptions:

1. This section shall not apply to water heater and boiler drain valves that are provided with hose connection threads and that are intended only for tank or vessel draining.
2. This section shall not apply to water supply valves intended for connection to clothes washing machines where backflow prevention is otherwise provided or is integral with the machine.

608.16 Connections to the Potable Water System

Connections to the potable water system shall conform to Sections 608.16.1 through 608.16.10.

608.16.1 Beverage Dispensers

The water supply connection to carbonated beverage dispensers shall be protected against backflow by a double check valve with an intermediate atmospheric vent conforming to ASSE 1022, CSA B64.3.1 or by an air gap. The backflow preventer device and all piping downstream of the backflow preventer must be compatible with carbon dioxide gas.

Exception: If a backflow preventer which conforms to ASSE 1032 is installed on a carbonator that conforms to NSF 18, then the double check with intermediate atmospheric vent conforming to ASSE 1022 is not required to protect the water supply connection.

608.16.2 Connections to Boilers

The potable water supply to a boiler shall be equipped with a backflow preventer with an intermediate atmospheric vent, complying with ASSE 1012 or CSA B64.3. Where conditioning chemicals are introduced into the system, the potable water connection shall be protected by an air gap or a reduced pressure principle backflow preventer, complying with ASSE 1013, CSA B64.4 or AWWA C511.

608.16.3 Heat Exchangers

Heat exchangers utilizing an essentially toxic transfer fluid shall be separated from the potable water by double-wall construction. An air-gap open to the atmosphere shall be provided between the two walls. Heat exchangers utilizing an essentially nontoxic transfer fluid shall be permitted to be of single-wall construction.

608.16.4 Connections to Automatic Fire Sprinkler Systems and Standpipe Systems

The potable water supply to automatic fire sprinkler systems and standpipe systems shall be protected against backflow by a double check valve assembly or a reduced pressure principle backflow preventer.

Exceptions:

1. Where systems are installed as a portion of the water distribution system in accordance with the requirements of this code and are not provided with a fire department connection, isolation of the water distribution system shall not be required.
2. Isolation of the water distribution system is not required for deluge, preaction or dry pipe systems

608.16.4.1 Additives or Non-potable Sources

Where systems under continuous pressure contain chemical additives or antifreeze, or where systems are connected to non-potable secondary water supply, the potable water supply shall be protected against backflow by a reduced pressure principle backflow preventer. Where chemical additives or antifreeze are added to only a portion of an automatic fire sprinkler or standpipe system, the reduced pressure principle backflow preventer shall be permitted to be located so as to isolate that portion of the system. Where systems are not under continuous pressure, the potable water supply shall be protected against backflow by an air gap or a pipe applied atmospheric vacuum breaker conforming to ASSE 1001 or CSA B64.1.1.

608.16.5 Connections to Lawn Irrigation Systems

The potable water supply to lawn irrigation systems shall be protected against backflow by an atmospheric type vacuum breaker, a pressure type vacuum breaker or a reduced pressure principle backflow preventer. A valve shall not be installed downstream from an atmospheric vacuum breaker. Where chemicals are introduced into the system, the potable water supply shall be protected against backflow by a reduced pressure principle backflow preventer.

608.16.6 Connections Subject to Backpressure

Where a potable water connection is made to a non-potable line, fixture, tank, vat, pump or other equipment subject to backpressure, the potable water connection shall be protected by a reduced pressure principle backflow preventer.

608.16.7 Chemical Dispensers

Where chemical dispensers connect to the water distribution system, the water supply system shall be protected against backflow in accordance with Section 608.13.1, 608.13.2, 608.13.5, 608.13.6, 608.13.8 or 608.13.9.

608.16.8 Portable Cleaning Equipment

Where the portable cleaning equipment connects to the water distribution system, the water supply system shall be protected against backflow in accordance with Section 608.13.1, 608.13.2, 608.13.3, 608.13.7 or 608.13.8.

608.16.9 Dental Pump Equipment

Where dental pumping equipment connects to the water distribution system, the water supply system shall be protected against backflow in accordance with Section 608.13.1, 608.13.2, 608.13.5, 608.13.6 or 608.13.8.

608.16.10 Coffee machines and noncarbonated beverage dispensers

The water supply connection to coffee machines and noncarbonated beverage dispensers shall be protected by a backflow preventer conforming to ASSE 1022 or by an air gap.

608.17 Protection of individual water supplies

An individual water supply shall be located and constructed so as to be safeguarded against contamination in accordance with Ohio Department of Health Rule 3701-28 of the Ohio Administrative Code, "Private Water systems."

APPLICATION OF PROPER BACKFLOW PROTECTION FOR THESE SPECIFIC PLUMBING COMPONENTS

WATER POWERED BACKUP SUMP PUMPS

This cross connection shall be considered a high hazard connection and shall be protected by a backflow device or method that would provide high hazard protection against backsiphonage by the proper installation of a device providing such protection. These devices shall be one of the following Air gap, Reduced pressure principle backflow preventer, Pressure-type vacuum breaker, Atmospheric-type vacuum breaker, Spillproof vacuum breaker. For additional information refer to the Ohio Plumbing Code sections 608.13.1, 608.13.2, 608.13.5, 608.13.6 or 608.13.8. The Water purveyor may require containment protection at the service entrance.

POST TYPE BURY LAWN HYDRANTS

This cross connection shall be considered a high hazard connection and shall be protected by a backflow device or method that would provide high hazard protection against backsiphonage by the proper installation of a reduced pressure principle backflow preventer on the supply side of the hydrant. For additional information refer to the Ohio Plumbing Code section 608.13.2. The outlet at the hydrant shall be labeled in an appropriate manner indicating that it is non potable/non drinking water. The Water purveyor may require containment protection at the service entrance.

PIPING SYSTEMS CONTAINING ETHYLENE GLYCOL

These systems are prohibited to be directly connection to a public water system and domestic water systems. They shall be provided with an approved air gap separation.

WATER LUBRICATED/WATER SEAL SEWAGE PUMPS

These systems are prohibited to be direct connection to a public water system and domestic water systems. They shall be provided with an approved air gap separation. To supply water to these pumps from a public water system it shall be through a secondary pump system that provides the water to a storage tank by air gap from which the pump system draws its water for pressurization to these types of pumps.

OHIO DEPARTMENT OF COMMERCE BACKFLOW PREVENTION MANUAL

OHIO ADMINISTRATIVE CODE, OEPA

The following material is from the Ohio Administrative Code, and represents the regulations adopted by the Ohio Environmental Protection Agency on October 9, 1980. They replace and are essentially the same as Regulation HE-34 that was adopted by the Public Health Council of the Ohio Department of Health on April 15, 1972.

The local water supplier is responsible for and authorized to enforce these regulations, pertaining to containment principle protection, in his/her water distribution system.

The Ohio Environmental Protection Agency has published a Manual of Backflow Prevention and Cross-Connection Control which contains this Administrative Code and all of their rules, regulations, policies, guidelines and illustrations. You can obtain this manual by contacting the Operator Training Committee of Ohio at (614) 268-6820 or www.ohiowater.org.

Chapter 3745-95-02; Cross-Connections

- (A) No person shall install or maintain a water service connection to any premises where actual or potential cross-connections to a public water system or a consumer's water system may exist unless such actual or potential cross-connections are abated or controlled to the satisfaction of the supplier of water.

- (B) No person shall install or maintain any connection whereby water from an auxiliary water system may enter a public water system or consumer's water system unless the auxiliary water system, the method of connection and use of such system have been approved by the supplier of water and by the director as required by Section 6109.13 of the Revised Code.

Chapter 3745-95-03; Surveys and Investigations

- (A) The supplier of water shall conduct or cause to be conducted periodic surveys and investigations, of frequency acceptable to the director of water use practices within a consumer's premises to determine whether there are actual or potential cross-connections to the consumer's water system through which pollutants or contaminants could backflow into the public water system.

- (B) The supplier of water, or his authorized representative, shall have the right to enter premises served by the public water system at all reasonable times for the purpose of making surveys and investigations of water use practices within the premises.

OHIO DEPARTMENT OF COMMERCE BACKFLOW PREVENTION MANUAL

OHIO ADMINISTRATIVE CODE, OEPA

- (C) On request by the supplier of water, or his authorized representative, the consumer shall furnish the supplier of water, or his authorized representative, information of water use practices within the consumer's premises.
- (D) Paragraph (A) of this rule does not relieve the consumer of the responsibility for conducting, or causing to be conducted, periodic surveys of water use practices on his premises to determine whether there are actual or potential cross-connections in the consumer's water system through which pollutants or contaminants could backflow into a public water system or a potable consumer's water system.

Chapter 3745-95-04 Where Protection is Required

- (A) An approved backflow prevention device shall be installed on each service line to a consumer's water system serving premises, where in the judgement of the supplier of water or the director, a pollution, system, health or severe health hazard to the public water exists.
- (B) An approved backflow prevention device shall be installed on each service line to a consumer's water system serving premises where any of the following conditions exist:
 - (1) Premises having an auxiliary water system, unless such auxiliary system is accepted as an additional source by the supplier of water and the source is approved by the director;
 - (2) Premises on which any substance is handled in such a fashion as to create an actual or potential hazard to a public water system. This shall include premises having sources or systems containing process fluids or waters originating from a public water system which are no longer under the control of the supplier of water;
 - (3) Premises having internal cross-connections that, in the judgment of the supplier of water, are not correctable, or intricate plumbing arrangements which make it impractical to determine whether or not cross-connections exist;
 - (4) Premises where, because of security restrictions or other prohibitions or restrictions, it is impossible or impractical to make a complete cross-connection survey;
 - (5) Premises having a repeated history of cross-connections being established or re-established;
 - (6) Others specified by the director.

OHIO DEPARTMENT OF COMMERCE BACKFLOW PREVENTION MANUAL

OHIO ADMINISTRATIVE CODE, OEPA

(C) The following requirements apply to premises that have an auxiliary water system on the real property that is owned or under control of the consumer and adjacent to the premises”.

- 1) A physical separation shall be maintained between the public water system or a consumers’ water system and the auxiliary water system as required by paragraph (B) of rule 3745-95-02 of the Administrative Code: and
- 2) An approved backflow prevention device shall be installed on each service connection serving the consumers’ water system, unless the supplier of water does all of the following:
 - a. Determines, on a case-by-case basis, that the installation of an approved backflow prevention device is not required in consideration of factors including, but not limited to, the past history of cross connections being established or re-established on the premises, the ease or difficulty of connecting the auxiliary water system with the public water system on the premises, the presence or absence of contaminants on the property or other risk factors;
 - b. Requires the consumer to sign an agreement which specifies the penalties, including those set forth in rule 3745-95-08 of the Administrative Code, for creating a connection between the public water system and the auxiliary water system:
 - c. Conducts or causes to be conducted an inspection at least every twelve months to certify that no connection or means of connection has been created between the public water system and the auxiliary water system;
 - d. Maintains an inventory of each consumers’ premises, where an auxiliary water system is on or available to the premises, or on the real property adjacent to the premises; and
 - e. Develops and implements an education program to inform all consumers served by the public water system about the dangers of cross connections and how to eliminate cross connections.

OHIO DEPARTMENT OF COMMERCE BACKFLOW PREVENTION MANUAL

OHIO ADMINISTRATIVE CODE, OEPA

(D) An approved backflow prevention device shall be installed on each service line to a consumer's water system serving, but not necessarily limited to, the following types of facilities unless the director determines that no health, pollutional, or system hazard to the public water system exists:

- (1) Hospitals, mortuaries, clinics, nursing homes;
- (2) Laboratories;
- (3) Piers, docks, waterfront facilities;
- (4) Sewage treatment plants, sewage pumping stations, or storm water pumping stations;
- (5) Food or beverage processing plants;
- (6) Chemical plants;
- (7) Metal plating industries;
- (8) Petroleum processing or storage plants;
- (9) Radioactive material processing plants or nuclear reactors;
- (10) Car washes; and
- (11) Others specified by the director.

(E) An approved backflow prevention device shall be installed at any point of connection between a public water system or a potable consumer's water system and an auxiliary water system, unless such auxiliary system is acceptable as an additional source by the supplier of water and the source is approved by the director.

Chapter 3745-95-05 Type of Protection Required

(A) The type of protection required under paragraph (A), (B), (C) and (D) of Rule 3745-95-04 of the Ohio Administrative Code shall depend on the degree of hazard which exists as follows:

- (1) An approved air-gap separation shall be installed where a public water system can be contaminated with substances that could cause a severe health hazard;
- (2) An approved air-gap separation, or an approved reduced pressure assembly, or an approved reduced pressure detector assembly shall be installed where a public water system may be contaminated with substances that could cause a health or system hazard;
- (3) An approved air-gap separation, or an approved reduced pressure assembly, or an approved reduced pressure detector assembly, or an approved double check valve assembly, or an approved double check detector assembly shall be installed where a public water system may be polluted with substances that could cause a pollution hazard.

OHIO DEPARTMENT OF COMMERCE BACKFLOW PREVENTION MANUAL

OHIO ADMINISTRATIVE CODE, OEPA

- (B) The type of protection required under paragraph (E) of Rule 3745-95-04 of the Ohio Administrative Code shall be an approved air-gap separation or an approved interchangeable connection.
- (C) Where an auxiliary water system is used as a secondary source of water for a fire protection system, the provisions of paragraph (B) of this Rule for an approved air-gap separation or an approved interchangeable connection may be waived by the director (of the Ohio EPA) provided:
- (1) At premises where the auxiliary water system may be contaminated with substances that could cause a system, health or severe health hazard, a public water system or a consumer's water system shall be protected against backflow by installation of an approved reduced pressure principle backflow prevention device or an approved reduced pressure detector assembly;
 - (2) At all other premises, a public water system or a consumer's water system shall be protected against backflow by installation of an approved reduced pressure assembly, or an approved reduced pressure detector assembly, or an approved double check valve assembly, or an approved double check detector assembly;
 - (3) A public water system or a consumer's water system shall be the primary source of water for the fire protection system;
 - (4) The fire protection system shall be normally filled with water from a public water system or a consumer's water system;
 - (5) The water in the fire protection system shall be used for fire protection only, with no other use of water from the fire protection system downstream from the approved backflow prevention device.

Chapter 3745-95-06 Backflow Prevention Devices

- (A) Any backflow prevention device required by rules 3745-95-04 and 3745-95-05 of the Ohio Administrative Code shall be of a model or construction approved by the supplier of water and conform to at least one of the following standards.
- a. For air-gap separation :
 - i. American National Standards Institute standard A 112.1

OHIO DEPARTMENT OF COMMERCE BACKFLOW PREVENTION MANUAL

OHIO ADMINISTRATIVE CODE, OEPA

- b. For reduced pressure principle backflow prevention assemblies:
 - i. American Water Works Association standard C511-97
 - ii. American Society of Sanitary Engineering standard 1013-99
 - iii. Canadian Standards Association B64.4-01
 - iv. Foundation for Cross Connection Control and Hydraulic Research
Ninth Edition

 - c. For double check valve assemblies:
 - i. American Water Works Association standard C510-97
 - ii. American Society of Sanitary Engineering standard 1015-99
 - iii. Canadian Standards Association B64.5-01
 - iv. Foundation for Cross Connection Control and Hydraulic Research
Ninth Edition

 - d. For reduced pressure principle-detector assemblies
 - i. American Society of Sanitary Engineering standard 1047-99
 - ii. Canadian Standards Association B64.4.1-01
 - iii. Foundation for Cross Connection Control and Hydraulic Research
Ninth Edition

 - e. For double check-detector check valve assemblies:
 - i. American Society of Sanitary Engineering standard 1048-99
 - ii. Canadian Standards Association B64.5.1-01
 - iii. Foundation for Cross Connection Control and Hydraulic Research
Ninth Edition
- (B) Any backflow prevention device required by Rules 3745-95-04 and 3745-95-05 of the Ohio Administrative Code shall be installed at a location and in a manner approved by the supplier of water and at the expense of the water consumer. In addition, any backflow prevention device required by paragraphs (B) and (C) of Rule 3745-95-05 of the Ohio Administrative Code shall be installed in a location and in a manner approved by the director as required by Section 6109.13 of the Ohio Revised Code.
- (C) It shall be the duty of the consumer to maintain any backflow prevention device required by rules 3745-95-04 and 3745-95-05 of the Ohio Administrative Code in working order and in continuous operation.
- (1) The supplier of water shall retain authority over any backflow prevention device required by rules 3745-95 and 3745-95-05 of the Ohio Administrative Code.

OHIO DEPARTMENT OF COMMERCE BACKFLOW PREVENTION MANUAL

OHIO ADMINISTRATIVE CODE, OEPA

- (2) It shall be the duty of the supplier of water to see that the tests and inspections required under this paragraph are made.
 - (3) The consumer shall on any premises on which backflow prevention devices required by rules 3745-95-04 and 3745-95-05 of the Ohio Administrative Code are installed, to have thorough inspections and operational tests made of the devices at such intervals and in such manner as may be reasonably required by the supplier of water or the director.
 - (4) These inspections and tests shall be at the expense of the water consumer, and shall be performed by the supplier of water or a person approved by the supplier of water as qualified to inspect and test backflow prevention devices.
 - (5) These devices shall be repaired, overhauled, or replaced at the expense of the consumer whenever they are found to be defective.
 - (6) Records of such inspections, tests, repairs, and overhaul shall be kept by the consumer and made available to the supplier of water.
- (D) The supplier of water shall inspect or cause to be inspected all installations where an approved connection exists between auxiliary water and a consumer's water system at least once every twelve months and shall maintain an inventory of all such installations and inspection records. Such inventories and inspection records shall be made available during sanitary surveys and at other reasonable times.
- (E) Backflow prevention devices approved by the supplier of water and conforming to prior or subsequent editions of the standards cited in paragraph (A) of this rule, and which are properly maintained in accordance with paragraph (C) of this rule, shall be excluded from the requirements of paragraphs (A) and (B) of this rule if the supplier of water and the director are assured that the devices will satisfactorily protect the public water system.

OHIO DEPARTMENT OF COMMERCE BACKFLOW PREVENTION MANUAL

OHIO ADMINISTRATIVE CODE, OEPA

Chapter 3745-95-07 Booster Pumps

- (A) No person shall install or maintain a water service connection to any one, two, or three family dwelling where a booster pump has been installed, unless an air-gap separation is provided to ensure that the booster pump can not exert suction on the service line.
- (B) For booster pumps not intended to be used for fire suppression, no person shall install or maintain a water service connection to any premises not included in (A) of this rule where a booster pump has been installed on the service line to or within such premises, unless such booster pump is equipped with a low-suction pressure cut-off controller designed to shut off the booster pump when the pressure in the service line on the suction side of the pump drops to ten pounds per square inch gauge or less.
- (C) For booster pumps used for fire suppression installed after the effective date of this rule, no person shall install or maintain a water service connection to any premises not included in (A) of this rule where a booster pump has been installed on the service line to or within such premises, unless the pump is equipped with a minimum pressure-sustaining valve on the booster pump discharge, which throttles the discharge of the pump when necessary so that suction pressure will not be reduced below ten pounds per square inch gauge while the pump is operating.
- (D) For booster pumps used for fire suppression installed prior to the effective date of this rule, no person shall install or maintain a water service connection to any premises not included in (A) of this rule where a booster pump has been installed on the service line to or within such premises, unless the pump is equipped with either a low-suction pressure cut-off controller designed to shut off the booster pump when the pressure in the service line on the suction side of the pump drops to ten pounds per square inch gauge or less, or a minimum pressure-sustaining valve on the booster pump discharge, which throttles the discharge of the pump when necessary so that suction pressure will not be reduced below ten pounds per square inch gauge while the pump is operating.
- (E) It shall be the duty of the water consumer to maintain the low-suction pressure cut-off controller in proper working order and to certify to the supplier of water, at least once every twelve months that the device is operable and maintained in continuous operation.

**OHIO DEPARTMENT OF COMMERCE
BACKFLOW PREVENTION MANUAL**

OHIO ADMINISTRATIVE CODE, OEPA

Chapter 3745-95-08 Violations

- (A) The supplier of water shall deny or discontinue, after reasonable notice to the occupant thereof, the water service to any premises wherein any backflow prevention device required by this Chapter is not installed, tested, and maintained in a manner acceptable to the supplier of water, or if it is found that the backflow prevention device has been removed or bypassed, or if an unprotected cross-connection exists on the premises, or if a low-suction pressure cut-off controller is not installed or maintained in working order, or if the supplier of water or the director or the authorized representative of either, is denied entry to determine compliance with these Rules of the Ohio Administrative Code.
- (B) Water service to such premises shall not be restored until the consumer has corrected or eliminated such conditions or defects to the satisfaction of the supplier of water.

OHIO DEPARTMENT OF COMMERCE BACKFLOW PREVENTION MANUAL

OHIO ADMINISTRATIVE CODE, OEPA

APPROVED YARD HYDRANTS

Chapter 3745-95-09

The following yard hydrants are currently accepted by the Ohio EPA as models that will drain water from the barrel by a means other than drain ports below grade and do not require a backflow prevention assembly.

American, Model 126 & 226

Eclipse Freeze Flow Model

Murdock Accello (Sanitary Post Type)

Woodford, Model S4

(A) Yard hydrants with weep holes are prohibited.

(C) Sanitary yard hydrants that do not have weep holes, such as those that meet the requirements of the “American Society of Sanitary Engineers (ASSE) Standard 1057, Performance Requirements for Freeze Resistant Yard Hydrants with Backflow Protection” (2001) are not prohibited provided:

- i. The device is acceptable to the public water system to which it will be connected; and
- ii. All of the backflow and cross-connection requirements of this Chapter of the Administrative Code are met.

OHIO DEPARTMENT OF COMMERCE BACKFLOW PREVENTION MANUAL

POLICY ON THE USE OF ANTIFREEZE

The Ohio Environmental Protection Agency and the Ohio Department of Commerce agree that the use of ethylene glycol antifreeze in a consumer's water system poses a severe high/severe health hazard.

These regulatory agencies require that an approved air-gap separation shall be installed at the water supply make-up line to any piping system that contains ethylene glycol based antifreeze.

If an approved antifreeze is used (see 1 and 2 below), then an approved reduced pressure principle backflow prevention device may be installed as protection on the water supply make-up line.

The following information is provided as general information and to assist in the protection of a public water system when an antifreeze solution is required to prevent freezing of fire protection systems.

1. Antifreeze solutions can consist of either pure glycerin solution, provided the glycerin solution is of 96.5 per cent United States pharmacopoeia grade, or of food- grade propylene glycol base.
2. Propylene glycol plus dipotassium phosphate is acceptable for use as an antifreeze solution. The propylene glycol is the antifreeze component and the dipotassium phosphate functions as a bacterial inhibitor.

An approved double check valve assembly (ASSE 1015) or an approved double check detector check assembly (ASSE 1048) must be installed at the service connection to a fire protection system that contains no additives

An approved reduced pressure principle backflow preventer (ASSE 1013) or an approved reduced pressure principle detector check assembly (ASSE 1047) must be installed at the service connection to a fire protection system that contains any additive.

If a fire protection system contains ethylene glycol antifreeze then an approved air-gap separation is required as backflow protection, but the ethylene glycol may be replaced with propylene glycol and an ASSE 1013 or 1047 is acceptable as protection.

OHIO DEPARTMENT OF COMMERCE BACKFLOW PREVENTION MANUAL

CHECK LIST FOR TESTING

ALL BACKFLOW ASSEMBLIES SHALL BE TESTED ON SITE WHILE INSTALLED IN THE PIPING SYSTEM AND SHALL NOT BE REMOVED FOR TESTING PURPOSES

When you test a backflow prevention assembly, you are certifying that a device is operating properly and that the readings that you indicate on the test sheet are accurate and true.

The following checklist is intended to assist you in preparing to perform a test:

- ✓ check that you have the work order for the test location address
- ✓ check that your gauge is accurately calibrated
- ✓ check that you have the appropriate test form

Upon arrival at the premises, the first thing that you should do is contact the owner or maintenance man and remind him that you will have to turn the water off to perform the test.

The following checklist is intended to provide direction as you approach the device:

- ✓ check the manufacturer, size and serial number on the device to ensure that you are at the right device
- ✓ check that all four test cocks are in place and accessible
- ✓ check that no connections have been made prior to the device
- ✓ check that a bypass has not been installed around the device
- ✓ check for signs of leakage on the floor if you are testing a reduced pressure principle backflow preventer

The first thing that you must do before beginning the test is to flush the test cocks. This removes any debris that may have accumulated in the test cock so that it does not enter the test gauge and damage the internal components.

When flushing the test cocks on a testing a reduced pressure assembly, you should use the following procedure to ensure that you do not cause the differential relief valve to open prior to your test.

- ✓ Slightly open test cock number 4 and let the water run
- ✓ Open and then close test cock number 2
- ✓ Open and then close test cock number 3
- ✓ Close test cock number 4

OHIO DEPARTMENT OF COMMERCE BACKFLOW PREVENTION MANUAL

THREE-VALVE ANALOG TEST GAUGE

To ensure the continued satisfactory operation of backflow prevention devices, the devices must be periodically inspected and tested by individuals who are approved by the supplier of water in the case of containment protection and by the Ohio DOC in the case of isolation protection.

All backflow preventers are equipped with test cocks and must be tested before being put into service and at least every twelve months thereafter.

If a device has been replaced or if the supply line piping is altered or changed, the device shall be tested before being returned to service.

A device shall be tested after any routine maintenance, such as cleaning or internal inspection. If a device is repaired or overhauled, it shall be tested before returning to service.

When testing an assembly, make sure that the high-pressure, low-pressure and vent hoses are connected to the proper test cocks. To avoid damage to the test gauge, open the test cocks slowly when bleeding air through the vent hose.

The gauge most commonly used to test a backflow prevention device is a pressure differential gauge. This gauge compares the difference between two pressures and indicates the difference between the two pressures. The gauge indicates pressure in pounds and two tenths of a pound as pounds per square inch differential or psid.

This illustration is intended to familiarize you with the components of the three-valve test gauge for your use in using the test procedures on pages 78 to 85.

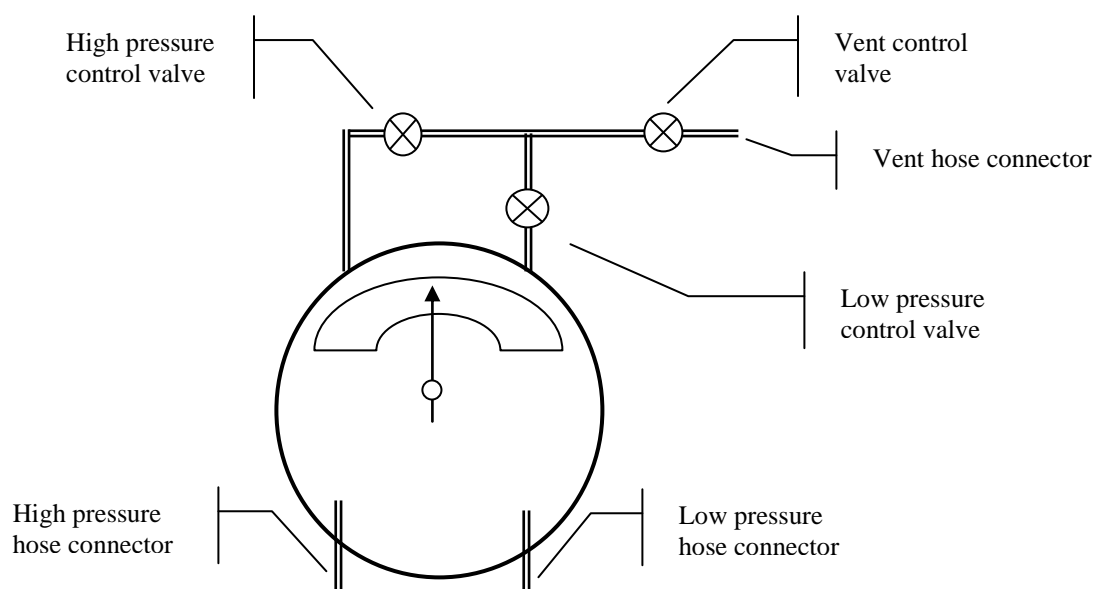

Figure 26

**OHIO DEPARTMENT OF COMMERCE
FIELD TEST PROCEDURE USING THREE VALVE GAUGE**

ASSE 1013 REDUCED PRESSURE PRINCIPLE ASSEMBLY

SETUP

- a. Install hose adapters and flush test cocks #2, #3, #4
- b. Close all control valves on the test gauge
- c. Close shut-off valve #2

TEST 1: Purpose: To test Check Valve #1
 Requirement: Check Valve #1 must indicate a pressure differential equal to or greater than 5 psid to continue the test

PROCEDURE

- a. Connect the high pressure hose to test cock #2
- b. Connect the low pressure hose to test cock #3
- c. Open test cock #3
- d. Open test cock #2
- e. Open the vent control valve on the gauge
- f. Open the high control valve to bleed any air from the hose and gauge
- g. Close the high control valve
- h. Open the low control valve to bleed any air from the hose and gauge
- i. Close the low control valve
- j. Observe the gage to verify that Check Valve #1 is creating a minimum pressure differential equal to or greater than 5 psid in order to continue the test. Record the reading on the test form

TEST 2: Purpose: To test the Pressure Differential Relief Valve
 Requirement: The Relief Valve must maintain a pressure differential of at least 2 psid between the Relief Valve Zone and the supply pressure

PROCEDURE

- a. Close the vent control valve
- b. Open the high control valve
- c. Slightly open the low control valve to slowly increase the water pressure in the intermediate pressure zone, the gauge needle should begin to drop toward zero and observe when water first begins to discharge from the relief port.
- d. Observe the gauge reading at which this discharge is first occurring and record the psid reading shown on the gauge.
- e. Record the Relief Valve as passed if water discharged at 2 psid or greater
- f. Compare the gauge reading obtained for Check Valve #1 and the Relief Valve. The Check Valve #1 psid must be 3psi or greater than the Relief Valve psid for Check Valve #1 to pass.
- g. Close the high and low control valves

CONTINUE TO TEST 3 & 4

OHIO DEPARTMENT OF COMMERCE FIELD TEST PROCEDURE USING THREE VALVE GAUGE

ASSE 1013 REDUCED PRESSURE PRINCIPLE ASSEMBLY

TEST 3: Purpose: To test Check Valve #2
Requirement: Check Valve #2 must hold tightly against backpressure

PROCEDURE

- a. Open the vent control valve
- b. Open the high control valve to bleed any air from the hose and gauge
- c. Close the high control valve
- d. Open the low control valve to bleed any air from the hose and gauge
- e. Close the low control valve
- f. Connect the vent hose to test cock #4
- g. Open the high control valve
- h. While observing the gauge, open test cock #4.

The gauge needle may drop slightly then should remain static if Check Valve #2 is holding tightly. If the gauge needle does not remain static and continues to drop downward and the relief valve starts to discharge water, then check valve #2 is leaking.

- i. Record Check Valve #2 as either pass or fail on the test form
-

TEST 4: Purpose: To test Shut-Off Valve #2
Requirement: Shut-Off Valve #2 must be drip-tight in order to obtain accurate test readings

PROCEDURE

- a. While observing the gauge, close test cock #2
The gauge needle may drop slightly then should remain static if Shut-Off Valve #2 is drip-tight. If the gauge needle continues to drop toward zero, then Shut-Off Valve #2 is leaking
- b. Open a fixture downstream of Shut-Off Valve #2 to create a flow and accurately determine if Shut-Off Valve #2 is holding tightly
- c. Record Shut-Off Valve #2 as pass or fail on the test form

Note: If Shut-Off Valve #2 is leaking, then you must repair or replace the valve and repeat all tests

- d. Open Shut-Off Valve #2
- e. Close all test cocks
- f. Remove the high, low and vent pressure hoses
- g. Open all control valves to drain the test gauge
- h. Remove the hose adapters from the test cocks
- i. Make sure that the water is on to the building

END OF TEST PROCEDURE –

OHIO DEPARTMENT OF COMMERCE FIELD TEST PROCEDURE USING THREE VALVE GAUGE

ASSE 1015 DOUBLE CHECK VALVE ASSEMBLY

SETUP

- a. Install hose adapters and flush test cocks #1, #2, #3, #4
 - b. Close all control valves on gauge
 - c. Close shut-off valve #2
-

TEST 1: Purpose: To test Shut-Off Valve #2
 Requirement: Shut-Off Valve #2 must be drip-tight in order to obtain accurate results for Tests #2 and #3

PROCEDURE

- a. Connect the high pressure hose to test cock # 1
- b. Connect the low pressure hose to test cock # 4
- c. Open test cock #1 then open test cock #4
- d. Open the high control valve
- e. Open the vent control valve to bleed any air from the hose and gauge
- f. Close the high control valve
- g. Open the low control valve to bleed any air from the hose and gauge do not close low control valve
- h. Close the vent control valve
- i. Close Shut-off Valve #1
- j. Open the high control valve
- k. Observe the gauge reading, it should be zero (0 psi)

If the needle on the gauge remains at zero, record Shut-off Valve #2 as holding tightly

If the needle on the gauge rises above zero, record Shut-off Valve #2 as leaking and it must be repaired before you can continue the test. A reading above zero is an indication that there is a pressure head loss through the gauge as the water flows past the leaking Shut-off Valve #2

- l. Open a fixture downstream of Shut-Off Valve #2 to create a flow and accurately determine if Shut-Off Valve #2 is holding tightly
- m. Close all control valves on the gauge
- n. Close test cocks #1 and #4 and disconnect the low and high pressure hoses
- o. Open Shut-off Valve #1

CONTINUE TO TEST 2 & 3

OHIO DEPARTMENT OF COMMERCE FIELD TEST PROCEDURE USING THREE VALVE GAUGE

ASSE 1015 DOUBLE CHECK VALVE ASSEMBLY

TEST 2: Purpose: To test Check Valve #1
Requirement: Check Valve #1 must create a pressure differential of at least 1 psid

PROCEDURE

- a. Verify that all control valves and Shut-Off Valve #2 are closed
 - b. Connect the high pressure hose to test cock #2
 - c. Connect the low pressure hose to test cock #3
 - d. Open test cock #3 then open test cock #2
 - e. Open the high control valve
 - f. Open the vent control valve to bleed any air from the hose and gauge
 - g. Close the high control valve
 - h. Open the low control valve to bleed any air from the hose and gauge
 - i. Close the low control valve.
 - j. Close the vent control valve
 - k. Observe and record the gauge reading on the test form.
The gauge reading must be 1 psid or greater for check valve #1 to pass. If the gauge needle reads less than 1 psid or continues to drop toward zero, then record check valve #1 as fail
 - l. Close test cocks #2 and #3 and disconnect the low and high pressure hoses
-

TEST 3: Purpose: To test Check Valve #2
Requirement: Check Valve #2 must create a pressure differential of at least 1 psid

PROCEDURE

- a. Connect the high hose to test cock #3
- b. Connect the low hose to test cock #4
- c. Open test cock #4 then open test cock #3
- d. Open the high control valve
- e. Open the vent control valve to bleed any air from the hose and gauge
- f. Close the high control valve
- g. Open the low control valve to bleed any air from the hose and gauge
- h. Close the low control valve.
- i. Close the vent control valve
- j. Observe and record the gauge reading on the test form.
The gauge reading must be 1 psi or greater for check valve #2 to pass. If the gauge needle reads less than 1.0 psi or drops toward zero, then record check valve #2 as fail
- k. Close test cocks #3 and #4 and disconnect the low and high pressure hoses
- l. Open shut-off valve #2
- m. Open all of the control valves to drain the water in the gauge
- n. Remove the hose adapters
- o. Make sure that the water is back on to the building

- END OF TEST PROCEDURE -

OHIO DEPARTMENT OF COMMERCE FIELD TEST PROCEDURE USING THREE VALVE GAUGE

ASSE 1020 PRESSURE VACUUM BREAKER

SETUP

- a. Install hose adapters and flush test cocks #1 and #2
 - b. Close all control valves on test equipment
 - c. Remove the air inlet canopy
-

TEST 1: Purpose: To test the Air Inlet Valve
 Requirement: The Air Inlet Valve must open when the pressure in the valve body drops to 1.0 psig above atmospheric pressure, and the air inlet valve must open fully when all of the water has drained from the valve body.

Note: It is important that the test gauge be positioned at the same elevation as the vacuum breaker during test #1 in order to eliminate any effect from a water column created in the hose.

PROCEDURE

- a. Connect the high hose to test cock #2
- b. Slowly open test cock #2 so that you do not slam the gauge needle
- c. Open the high control valve
- d. Open the vent control valve to bleed any air from the hose and gauge
- e. Close the vent control valve
- f. Close Shut-Off Valve #2
- g. Close Shut-Off Valve #1
- h. Slightly open the low control valve to allow the water pressure in the body of the pressure vacuum breaker to fall slowly while observing the pressure differential gauge.

You may touch (but do not push) the air inlet valve to feel for the first movement as it opens; in a quiet area you can hear the air inlet valve open.

- i. Record the pressure differential, at which the air inlet valve opened, on the test form.
The gauge reading at the point of opening must be 1 psig or greater for the air inlet valve to pass
- j. Close the low control valve
- k. Close test cock #2 and disconnect the hose
- l. Open Shut-Off Valve #1 quickly in order to reseal the air inlet valve and re-pressurize the assembly

CONTINUE TO TEST 2

OHIO DEPARTMENT OF COMMERCE FIELD TEST PROCEDURE USING THREE VALVE GAUGE

ASSE 1020 PRESSURE VACUUM BREAKER

TEST 2: Purpose: To test the Check Valve
 Requirement: The Check Valve must be drip-tight in the normal direction of flow when the inlet pressure is 1.0 psig and the outlet pressure is atmospheric

PROCEDURE

- a. Connect the high hose to test cock #1
- b. Slowly open test cock #1 so that you do not slam the gauge needle
- c. Open the vent control valve to bleed any air from the hose and gauge
- d. Close the vent control valve
- e. Close Shut-Off Valve #1
- f. Fully open test cock #2.

This will drain the water from the body of the vacuum breaker and open the air inlet valve. When the flow from test cock #2 stops, lift the gauge to place pressure against the check valve in the direction of flow. The pressure reading indicated on the gauge will be the pressure drop across the check valve.

- g. Record the gauge reading on the test form.
The gauge reading must be 1 psig or greater for the check valve to pass.
- h. Close test cocks #1 and #2, then disconnect the hose
- i. Open Shut-off Valve #1 quickly in order to seat the air inlet valve and re-pressurize the assembly
- j. Open Shut-Off Valve #2
- k. Re-install the air inlet canopy
- l. Open all of the control valves to drain the water in the gauge
- m. Remove the hose adapters
- n. Make sure that the water is back on to the building

- END OF TEST PROCEDURE -

**OHIO DEPARTMENT OF COMMERCE
FIELD TEST PROCEDURE USING THREE VALVE GAUGE**

ASSE 1056 BACKSIPHONAGE VACUUM BREAKER

SETUP

- A. Before starting test close all valves on the test gauge
- B. Flush test cock before testing

Test No. # 1 - Differential Test of Check Valve

Requirement: Differential pressure across check must be 1.0 PSID or above

- Step 1** Remove screws on top of hood then remove hood.
- Step 2** Connect high hose of test gauge to test cock.
- Step 3** Open test cock and high valve on test gauge.
- Step 4** Open the vent (bypass) valve on the test gauge to bleed air from hose then close the vent (bypass) valve on the test gauge.
- Step 5** Close shut-off valve #2 then close shut-off valve #1 on backflow assembly.
- Step 6** Slowly unscrew bleed screw on spill proof vacuum breaker body to relieve pressure down stream of check and remove screw completely.
- Step 7** When dripping from bleed screw stops elevate gauge about 1-2 feet above device to remove loop in high hose. While gauge is elevated observe and record the differential pressure.

RESULT Differential pressure on gauge must be 1.0 PSID or greater for check to test satisfactorily.

CONTINUE TO TEST 2

OHIO DEPARTMENT OF COMMERCE FIELD TEST PROCEDURE USING THREE VALVE GAUGE

ASSE 1056 BACKSIPHONAGE VACUUM BREAKER

Note: For the following test the tester must be held at the same level as the assembly being tested.

Test # 2 - Air Inlet - Vent Opening

Requirement: Air inlet must start to open when supply pressure is 1.0 PSI or above. Air inlet must be fully open when supply pressure is atmospheric

Step 8 Slowly open low (needle) valve until the vent opens slightly (1/32") then close low (needle) valve. Observe gauge and record gauge PSID. Gauge PSID must be 1.0 or greater at which vent opens to pass test as opening.

Step 9 Open low (needle) valve fully until dripping from low hose stops. While opening low (needle) valve observe vent that it opens fully.

Step 10 Visually inspect that the vent is fully open. It must be open fully to pass test satisfactorily.

Step 11 Replace and tighten bleed screw, close test cock and remove high hose.

Step 12 Open shut-off valve #1 and then open shut-off valve #2 to restore backflow device to original working condition. Replace hood and screws on top of assembly.

Note: After test, all valves on test gauge must be fully open to prevent damage to test gauge

END OF TEST PROCEDURE

OHIO DEPARTMENT OF COMMERCE BACKFLOW PREVENTION MANUAL

FIVE-VALVE ANALOG TEST GAUGE

The five-valve analog gauge works exactly the same as the three-valve analog gauge. It compares the difference between two pressures and the gauge needle indicates the difference between the two pressures. The gauge indicates pressure in pounds and two tenths of a pound **as pounds per square inch differential or psid.**

However due to the additional valves, the test steps are slightly different although the test procedures are exactly the same.

When testing an assembly, make sure that the high-pressure, low-pressure and vent hoses are connected to the proper test cocks. To avoid damage to the test gauge, open the test cocks slowly when bleeding air.

This illustration is intended to familiarize you with the components of the five-valve test gauge for your use in using the test procedures on pages 87 to 94.

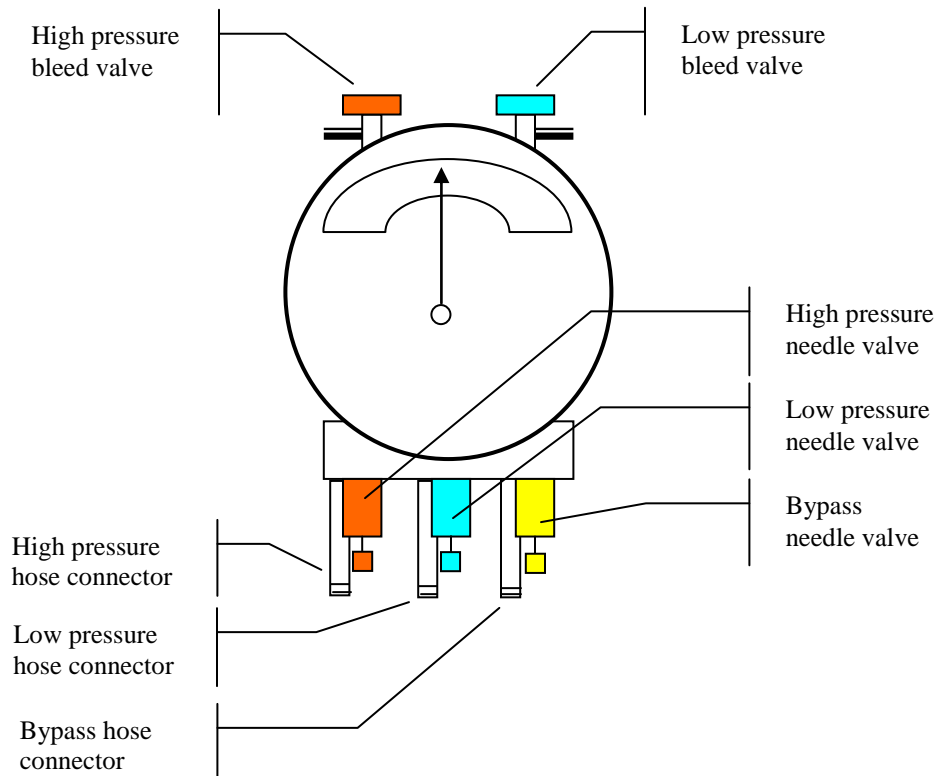

Figure 27

**OHIO DEPARTMENT OF COMMERCE
FIELD TEST PROCEDURE USING FIVE VALVE GAUGE**

ASSE 1013 REDUCED PRESSURE PRINCIPLE ASSEMBLY

SETUP

- a. Install hose adapters and flush test cocks #2, #3, #4
 - b. Close all control valves on the test gauge
 - c. Connect the high, low and bypass hoses to the gauge
 - d. Close shut-off valve #2
-

TEST 1: Purpose: To test Check Valve #1
 Requirement: Check Valve #1 must indicate a pressure differential equal to or greater than 5 psid to continue the test

PROCEDURE

- a. Connect the high pressure hose to test cock #2
 - b. Connect the low pressure hose to test cock #3
 - c. Open test cock #3
 - d. Open the low pressure bleed valve to bleed air from the hose and gauge do not close low pressure bleed valve
 - e. Open test cock #2
 - k. Wait for the needle to stabilize, then open the high pressure bleed valve to bleed air from the hose and gauge
 - l. Close the high pressure bleed valve
 - m. Close the low pressure bleed valve
 - n. Observe the gauge to verify that Check Valve #1 is creating a minimum pressure differential equal to or greater than 5 psid in order to continue the test. Record the reading on the test form.
-

TEST 2: Purpose: To test the Pressure Differential Relief Valve
 Requirement: The Relief Valve must maintain a pressure differential of at least 2 psid between the Relief Valve Zone and the supply pressure

PROCEDURE

- a. Open the high pressure needle valve
- b. Slightly open the low control valve to slowly increase the water pressure in the intermediate pressure zone, the gauge needle should begin to drop toward zero and observe when water first begins to discharge from the relief port.
- c. Observe the gauge reading at which this discharge is first occurring and record the psid reading shown on the gauge.
- d. Record the Relief Valve as passed if water discharged at 2 psid or greater
- e. Compare the gauge reading obtained for Check Valve #1 and the Relief Valve. The Check Valve #1 psid must be 3psi or greater than the Relief Valve psid for Check Valve #1 to pass.
- f. Close the high and low control valves

CONTINUE TO TEST 3 & 4

OHIO DEPARTMENT OF COMMERCE FIELD TEST PROCEDURE USING FIVE VALVE GAUGE

ASSE 1013 REDUCED PRESSURE PRINCIPLE ASSEMBLY

TEST 3: Purpose: To test Check Valve #2
Requirement: Check Valve #2 must hold tightly against backpressure

PROCEDURE

- a. Loosely connect the bypass (vent) hose to test cock #4
- b. Open the vent control valve
- c. Open the low control valve to bleed any air from the hose and gauge
- d. Close the low control valve
- e. Tighten the bypass (vent) hose to test cock #4
- f. Open the high control valve
- g. While observing the gauge, open test cock #4.

The gauge needle may drop slightly then should remain static if Check Valve #2 is holding tightly. If the gauge needle does not remain static and continues to drop downward and the relief valve starts to discharge water, then check valve #2 is leaking.

- h. Record Check Valve #2 as either pass or fail on the test form

TEST 4: Purpose: To test Shut-Off Valve #2
Requirement: Shut-Off Valve #2 must be drip-tight in order to obtain accurate test readings

PROCEDURE

- a. While observing the gauge, close test cock #2

The gauge needle may drop slightly then should remain static if Shut-Off Valve #2 is drip-tight. If the gauge needle continues to drop toward zero, then Shut-Off Valve #2 is leaking

- b. Open a fixture downstream of Shut-Off Valve #2 to create a flow and accurately determine if Shut-Off Valve #2 is holding tightly
- c. Record Shut-Off Valve #2 as pass or fail on the test form

Note: If Shut-Off Valve #2 is leaking, then you must repair or replace the valve and repeat all tests

- d. Open Shut-Off Valve #2
- e. Close all test cocks
- f. Remove the high, low and bypass hoses
- g. Open all control valves to drain the test gauge
- h. Remove the hose adapters from the test cocks
- i. Make sure that the water is on to the building

- END OF TEST PROCEDURE -

OHIO DEPARTMENT OF COMMERCE FIELD TEST PROCEDURE USING FIVE VALVE GAUGE

ASSE 1015 DOUBLE CHECK VALVE ASSEMBLY

TEST 2: Purpose: To test Check Valve #1
Requirement: Check Valve #1 must create a pressure differential of at least 1 psid

PROCEDURE

- a. Verify that all control valves and Shut-Off Valve #2 are closed
- b. Connect the high pressure hose to test cock #2
- c. Connect the low pressure hose to test cock #3
- d. Open test cock #3
- e. Open the low pressure bleed valve to bleed air from the hose and gauge
- f. Open test cock #2
- g. Allow the gauge needle to stabilize, then open the high pressure bleed valve to bleed air from the hose and gauge
- h. Close the high pressure bleed valve
- i. Close the low pressure bleed valve
- j. Observe and record the gauge reading on the test form.
The gauge reading must be 1 psid or greater for check valve #1 to pass. If the gauge needle reads less than 1 psid or drops toward zero, then record check valve #1 as fail
- k. Close test cocks #2 and #3 and slowly bleed the gauge pressure through the bleed valves

TEST 3: Purpose: To test Check Valve #2
Requirement: Check Valve #2 must create a pressure differential of at least 1 psid

PROCEDURE

- a. Connect the high pressure hose to test cock #3
- b. Connect the low pressure hose to test cock #4
- c. Open test cock #4
- d. Open the low pressure bleed valve to bleed air from the hose and gauge
- e. Open test cock #3
- f. Allow the gauge needle to stabilize, then open the high pressure bleed valve to bleed air from the hose and gauge
- g. Close the high pressure bleed valve
- h. Close the low pressure bleed valve
- i. Observe and record the gauge reading on the test form.
The gauge reading must be 1 psid or greater for check valve #2 to pass. If the gauge needle reads less than 1 psid or drops toward zero, then record check valve #2 as fail
- j. Close test cocks #3 and #4 and slowly bleed the gauge pressure through the bleed valves
- k. Open shut-off valve #2
- l. Open all of the control valves to drain the water in the gauge
- m. Remove the hose adapters
- n. Make sure that the water is back on to the building

- END OF TEST PROCEDURE -

OHIO DEPARTMENT OF COMMERCE FIELD TEST PROCEDURE USING FIVE VALVE GAUGE

ASSE 1020 PRESSURE VACUUM BREAKER

SETUP

- a. Install hose adapters and flush test cocks #1 and #2
 - b. Connect the high, low and bypass hoses to the gauge
 - c. Close all control valves on test equipment
 - d. Remove the air inlet canopy
-

TEST 1: Purpose: To test the Air Inlet Valve
 Requirement: The Air Inlet Valve must open when the pressure in the valve body drops to 1 psig above atmospheric pressure, and the air inlet valve must open fully when all of the water has drained from the valve body.

Note: It is important that the test gauge be positioned at the same elevation as the vacuum breaker during test #1 in order to eliminate any effect from a water column created in the hose.

PROCEDURE

- a. Connect the high pressure hose to test cock #2
- b. Open the high pressure bleed valve
- c. Slowly open test cock #2 so that you do not slam the gauge needle
- d. Close the high pressure bleed valve
- e. Close Shut-Off Valve #2
- f. Close Shut-Off Valve #1
- g. Slightly open the high pressure bleed valve to allow the water pressure in the body of the pressure vacuum breaker to fall slowly while observing the pressure differential gauge.

You may touch (but do not push) the air inlet valve to feel for the first movement as it opens; in a quiet area you can hear the air inlet valve open.

- h. Record the pressure differential, at which the air inlet valve opened, on the test form.
The gauge reading at the point of opening must be 1 psig or greater for the air inlet valve to pass
- i. Close test cock #2 and disconnect the hose
- j. Open Shut-Off Valve #1 quickly in order to reseal the air inlet valve and re-pressurize the assembly

CONTINUE TO TEST 2

OHIO DEPARTMENT OF COMMERCE FIELD TEST PROCEDURE USING FIVE VALVE GAUGE

ASSE 1020 PRESSURE VACUUM BREAKER

<u>TEST 2:</u>	Purpose:	To test the Check Valve
	Requirement:	The Check Valve must be drip-tight in the normal direction of flow when the inlet pressure is 1.0 psig and the outlet pressure is atmospheric

PROCEDURE

- a. Connect the high pressure hose to test cock #1
- b. Open the high pressure bleed valve
- c. Slowly open test cock #1 so that you do not slam the gauge needle
- d. Close the high pressure bleed valve
- e. Close Shut-Off Valve #1
- f. Fully open test cock #2.

This will drain the water from the body of the vacuum breaker and open the air inlet valve. When the flow from test cock #2 stops, lift the gauge to place pressure against the check valve in the direction of flow. The pressure reading indicated on the gauge will be the pressure drop across the check valve.

- g. Record the gauge reading on the test form.
The gauge reading must be 1 psig or greater for the check valve to pass.
- h. Close test cocks #1 and #2, then disconnect the hose
- i. Open Shut-off Valve #1 quickly in order to seat the air inlet valve and re-pressurize the assembly
- j. Open Shut-Off Valve #2
- k. Re-install the air inlet canopy
- l. Open all of the needle valves to drain the water in the gauge
- m. Remove the hose adapters
- n. Make sure that the water is back on to the building

- END OF TEST PROCEDURE -

**OHIO DEPARTMENT OF COMMERCE
FIELD TEST PROCEDURE USING FIVE VALVE GAUGE**

ASSE 1056 BACKSIPHONAGE VACUUM BREAKER

SETUP

- A. Before starting test close all valves on the test gauge
- B. Flush test cock before testing

Test No. # 1 - Differential Test of Check Valve

Requirement: Differential pressure across check must be 1.0 PSID or above

- Step 1** Remove screws on top of hood then remove hood.
- Step 2** Connect high hose of test gauge to test cock.
- Step 3** Open test cock and high valve on test gauge.
- Step 4** Open high pressure bleed valve on test gauge to bleed air from hose then close high pressure bleed valve on test gauge.
- Step 5** Close shut-off valve #2 then close shut-off valve #1 on backflow assembly.
- Step 6** Slowly unscrew bleed screw on spill proof vacuum breaker body to relieve pressure down stream of check and remove screw completely.
- Step 7** When dripping from bleed screw stops elevate gauge about 1-2 feet above device to remove loop in high hose. While gauge is elevated observe and record the differential pressure.

RESULT Differential pressure on gauge must be 1.0 PSID or greater for check to test satisfactorily.

CONTINUE TO TEST 2

OHIO DEPARTMENT OF COMMERCE FIELD TEST PROCEDURE USING FIVE VALVE GAUGE

ASSE 1056 BACKSIPHONAGE VACUUM BREAKER

Note: For the following test the tester must be held at the same level as the assembly being tested.

Test # 2 - Air Inlet - Vent Opening

Requirement: Air inlet must start to open when supply pressure is 1.0 PSI or above. Air inlet must be fully open when supply pressure is atmospheric

Step 8 Slowly open low (needle) valve until the vent opens slightly (1/32") then close low (needle) valve. Observe gauge and record gauge PSID. Gauge PSID must be 1.0 or greater at which vent opens to pass test as opening.

Step 9 Open low (needle) valve fully until dripping from low hose stops. While opening low (needle) valve observe vent that it opens fully.

Step 10 Visually inspect that the vent is fully open. It must be open fully to pass test satisfactorily.

Step 11 Replace and tighten bleed screw, close test cock and remove high hose.

Step 12 Open shut-off valve #1 and then open shut-off valve #2 to restore backflow device to original working condition. Replace hood and screws on top of assembly.

Note: After test, all valves on test gauge must be fully open to prevent damage to test gauge

END OF TEST PROCEDURE

STATE OF OHIO

Annual Test & Maintenance Report for Backflow Prevention Assemblies

Facility Name: _____

Address: _____ **Contact Person:** _____

Assembly Information

Make: _____

Model: _____

Size: _____

Serial Number: _____

Installation Information

Containment _	Isolation _
---------------	-------------

Meter Pit _ Basement _ Floor Number: _____

Penthouse _ Boiler Room _ Room Number: _____

Mechanical Room _ Protection Provided: _____

Double Check Assembly			
Initial Test	Outlet Valve		Pass _ Fail _
	1 st Check Valve	___psid	Pass _ Fail _
Date _____	2 nd Check Valve	___psid	Pass _ Fail _

Reduced Pressure Assembly		
1 st Check Valve	___ psid	Pass _ Fail _
Relief Valve Opening Point	___ psid	Pass _ Fail _
2 nd Check Valve		Pass _ Fail _
Outlet Valve	Pass _	Fail _

Pressure Vacuum Breaker		
Air Inlet Valve	___ psig	Pass _ Fail _
Check Valve	___ psig	Pass _ Fail _

Repairs & Materials Used	
-------------------------------------	--

--

--

Double Check Assembly			
Re-Test After	Outlet Valve		Pass _ Fail _
	1 st Check Valve	___psid	Pass _ Fail _
Date _____	2 nd Check Valve	___psid	Pass _ Fail _

Reduced Pressure Assembly		
1 st Check Valve	___ psid	Pass _ Fail _
Relief Valve Opening Point	___ psid	Pass _ Fail _
2 nd Check Valve		Pass _ Fail _
Outlet Valve	Pass _	Fail _

Pressure Vacuum Breaker		
Air Inlet Valve	___ psig	Pass _ Fail _
Check Valve	___ psig	Pass _ Fail _

Comments:

TESTER CERTIFICATION: *I hereby certify that the above data is correct and that the backflow prevention device is in proper working condition.*

Tester Name (Printed) _____ **Signature** _____

Company Name _____ **Ohio Cert. No.** _____ **Contractor No** _____ **Date** _____

I hereby certify that the above backflow prevention device has been in constant use at this location during the entire prescribed interval between test periods and during that period this device was not bypassed, made inoperative or removed without proper authorization. I further certify that I have the authority and responsibility to ensure the above.

Owner/Officer (Printed) _____ **Signature** _____

Title: _____ **Date:** _____

OHIO DEPARTMENT OF COMMERCE BACKFLOW PREVENTION MANUAL

TEST GAUGE RECALIBRATION

The test gauge should be carried in a sturdy case and protected from freezing conditions. If you suspect that the gauge has been damaged, from dropping or freezing, then the gauge should be re-calibrated before being used.

There currently is no State requirement that the gauge must be re-calibrated annually, but this is a recommended practice.

The following companies listed are for your information only and offer re-calibration and repair services:

Flats Industrial Services
1291 Winslow Ave
Cleveland, OH 44113
216-472-4720

Calibrations Complete
5199 Gaymon Drive
Hilliard, OH 43026
614-529-1115

ISL Corporation
1530 Page Industrial Boulevard
St. Louis, MO 63132
314-423-3141

Wayac Calibration Services
2899 Hilliard Rome Rd
Hilliard, OH 43026
614-529-4556

Winstel Controls
1423 Queen City Ave
Cincinnati, OH 45214
513-251-4343

Process Instruments
615 East Carson St.
Pittsburgh, PA. 15203
412-431-4600

Orange Research Incorporated
140 Cascade Boulevard
Milford, CT 06460
203-877-5657

American Backflow Calibration
4736 E Walnut St. Bldg. 2
Westerville, OH 43081
614-776-1234

Volumetrics Incorporated
3010 Rollie Gates Drive
Paso Robles, CA 93447
805-239-0110

Broadview Instrumentation Service
7632 B Hub Parkway
Valley View, OH 44125
216-525-0050

Gage-It, Inc.
Sellersville, PA
800-869-7294

**OHIO DEPARTMENT OF COMMERCE
BACKFLOW PREVENTION MANUAL**

ASSE 1013 PARTS CROSS SECTION

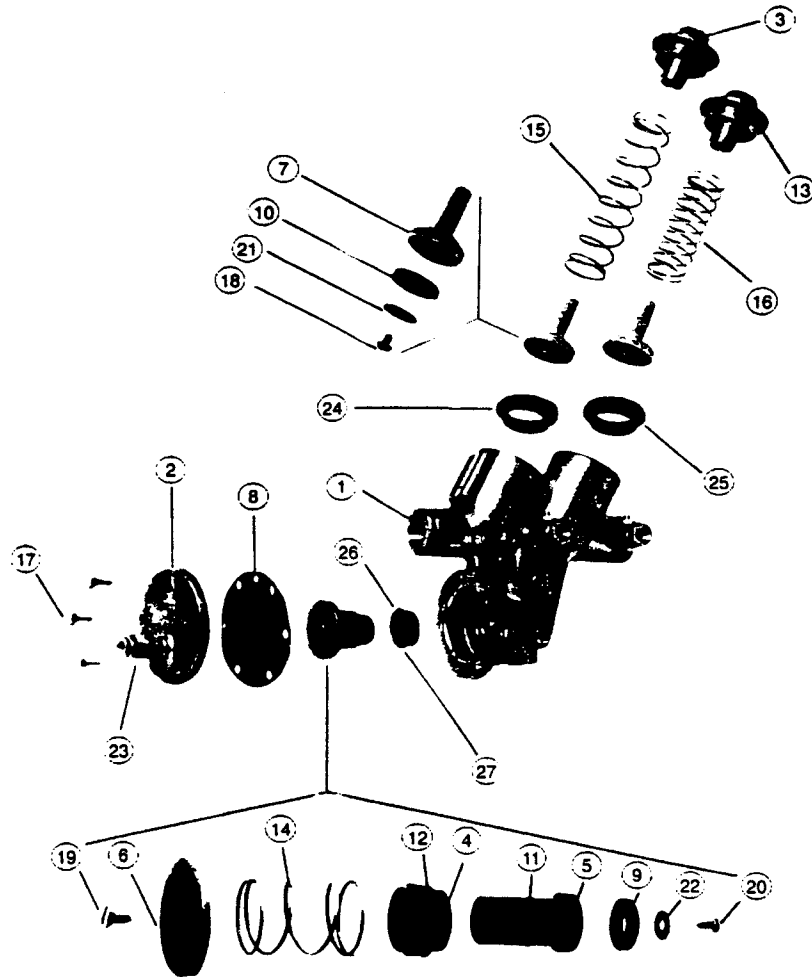

BACKFLOW PREVENTER COMPONENTS

1	Body	10	Check Valve Disc	19	Screw
2	Relief Valve Cover	11	Stem O-Ring	20	Screw
3	Check Valve Cap	12	Bushing O-Ring	21	Check Disc Retaining Washer
4	Relief Valve Bushing	13	Check Valve Cap O-Ring	22	Relief Disc Retaining Washer
5	Relief Valve Stem	14	Relief Valve Spring	23	Test cock Number 2
6	Diaphragm Plate	15	1 st Check Spring	24	Check seat
7	Check Valve Disc Holder	16	2 nd Check Spring	25	Check Seat O-Ring
8	Relief Valve Diaphragm	17	Hex Head Bolt	26	Relief Valve Seat
9	Relief Valve Disc	18	Screw	27	Relief Valve O-Ring

**OHIO DEPARTMENT OF COMMERCE
BACKFLOW PREVENTION MANUAL**

ASSE 1015 PARTS CROSS SECTION

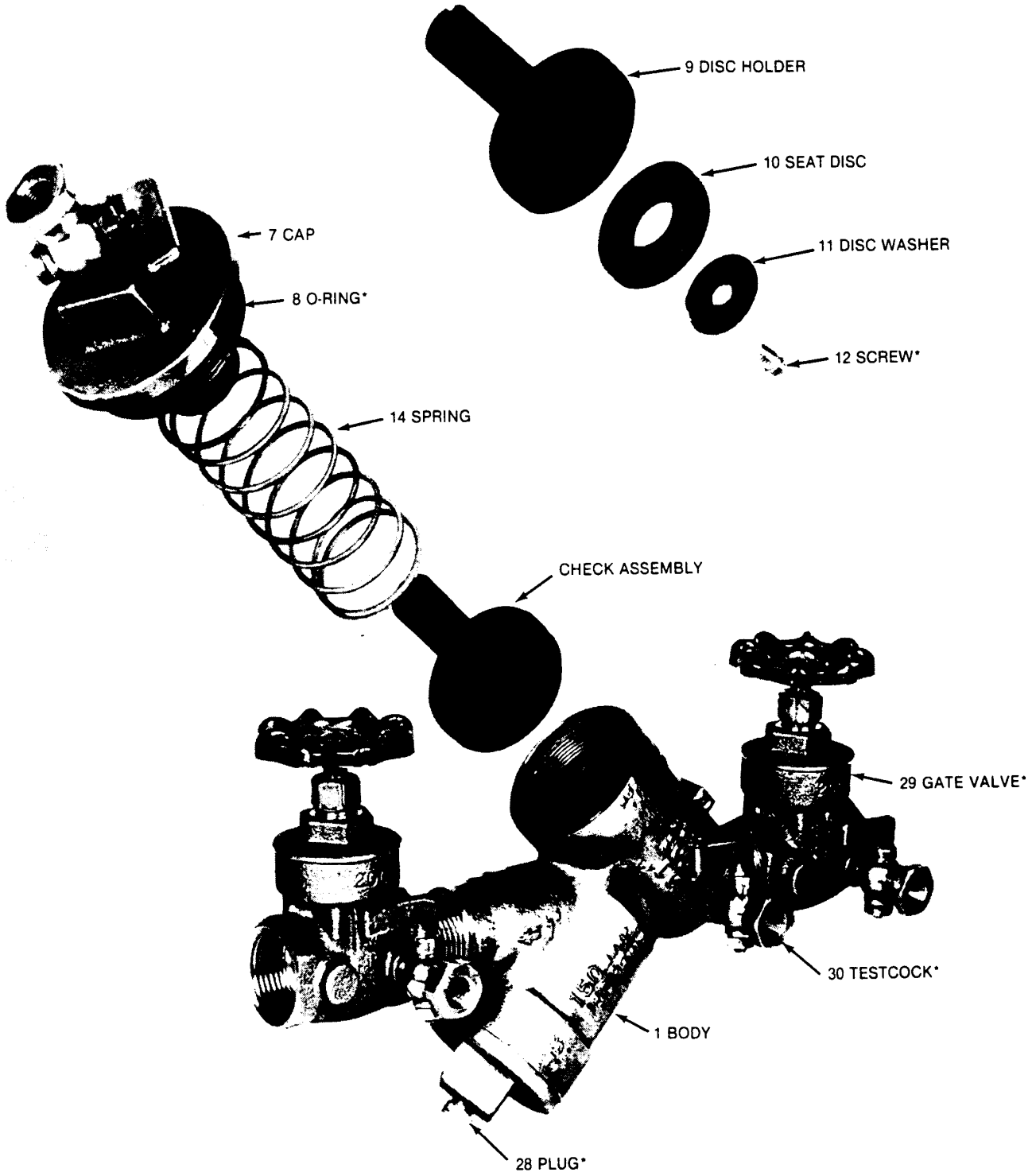

OHIO DEPARTMENT OF COMMERCE BACKFLOW PREVENTION MANUAL

ASSE 1020 PARTS CROSS SECTION

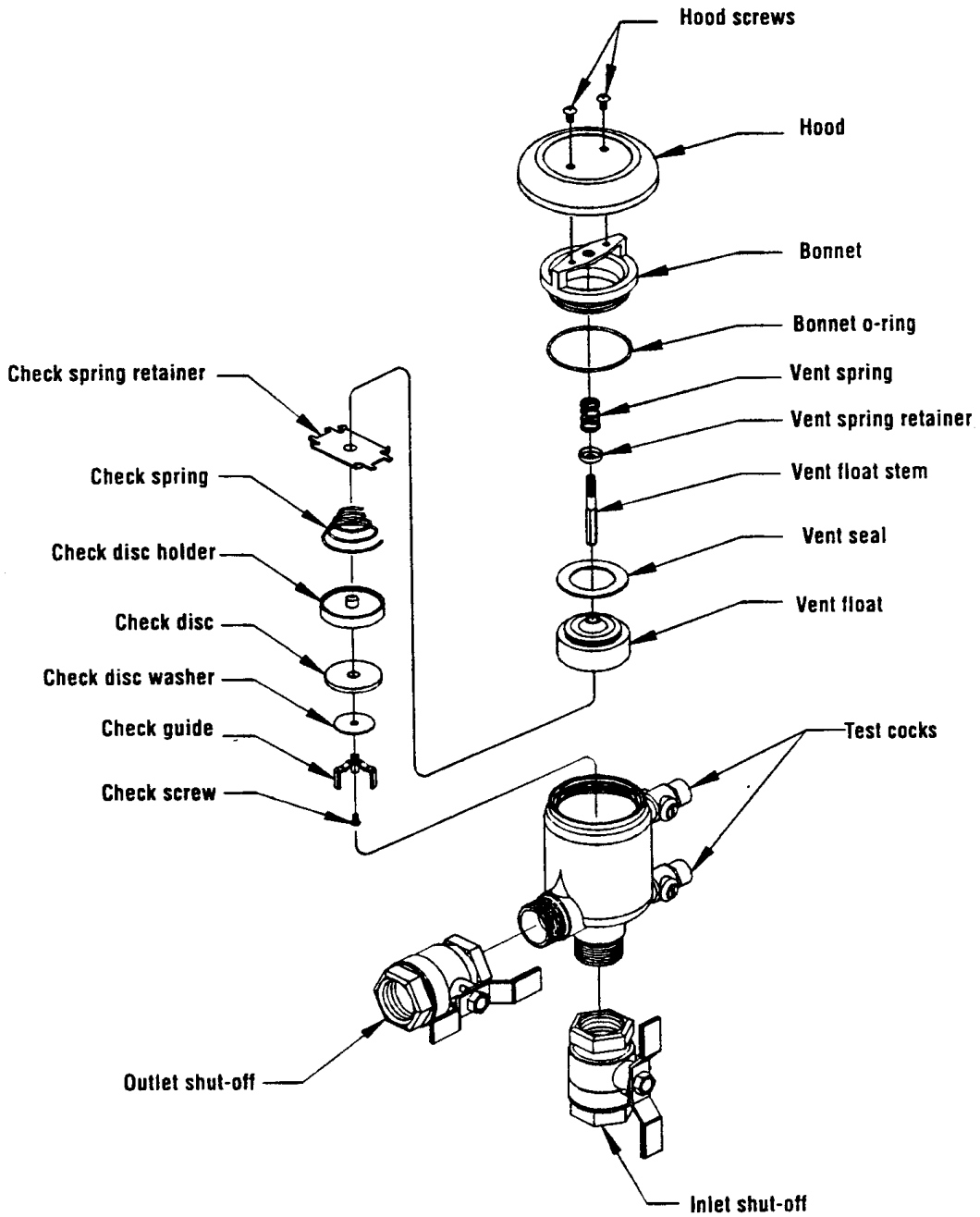

DEPARTMENT OF COMMERCE BACKFLOW PREVENTION MANUAL

TESTER SAFETY

All safety precautions as outlined in the applicable OSHA subpart sections should be followed when working from ladders, in confined spaces and other working conditions covered by OSHA regulations.

You should test the atmosphere in a pit before entering to determine that the oxygen levels are appropriate. Additionally, many companies will require the use of approved safety apparatus if you are entering a “confined space”. Check with the company contact person before entering a confined space.

Oxygen sensors are commercially available for testing the atmosphere. Keep in mind that if you are going to invest the money in a sensor then you may want to invest a little more and purchase a sensor that detects oxygen, methane gas, carbon dioxide, and explosive or flammable gases.

You will have to repair a backflow prevention device if it fails your test. For the safety of your customer, it is recommended that you have appropriate repair parts with you or ready access to repair parts so that you can return the backflow preventer to service after the test.

When you have to repair a backflow preventer, you must exercise caution when removing the cap to gain access to the check valve. Remember that the spring may be tensioned against the cap and will be exerting pressure against it.

This is especially important when removing the cap from a device that is greater than two inches in size. It is recommended that you carry two long bolts in your toolbox. You may then remove two bolts from the cap and insert the longer bolts. You may then remove the remaining bolts safely and slowly back-out the two longer bolts. The spring tension against the cap is relieved when you can push the cap downward with your hands.

Often backflow prevention devices are not easily accessible (this writer has seen them installed thirty feet in the air). Remember when you install a backflow prevention device that you may be the one who is also asked to test or repair it.

The water supplier will have specific installation requirements for a containment principle backflow prevention device. Check with the water supplier before beginning the installation.

There are few installation requirements for an isolation device at present. These should be installed according to the applicable plumbing code installation requirement or the manufacturer’s recommendations if there is no direction in the plumbing code.

**OHIO DEPARTMENT OF COMMERCE
BACKFLOW PREVENTION MANUAL**

OHIO MANUFACTURER REPRESENTATIVES

AMES

Hydrosource
8182 Chagrin Road
Chagrin Falls, Ohio 44023
(614) 895-0513

Hydrosource
2161 Baringer Avenue
Louisville, KY 40204
(502) 458-4321

APOLLO (CONBRACO)

Morrissey Associates
PO Box 187
North Jackson, Ohio 44451
(330) 538-0406

David Madsen
759 West Columbus Street
Pickerington, Ohio 43147
(614) 837-2039

FLOMATIC

Danfoss Water Valves
145 Murray Street
Glen Falls, NY 12801
(518) 761-9797

FEBCO

Kerr Marketing Agency
10001 York Theta Drive
Cleveland, Ohio 44133
(440) 582-1720

US Filter
1446 Troy Road
Ashland, Ohio 44805
(800) 262-0607

WATTS

Disney-McLane
428 McGregor Street
Cincinnati, Ohio 45206
(513) 861-1682

WILKINS-ZURN

BWA
10869 Reading Road
Cincinnati, Ohio 45241
(513) 733-4771

BWA
4501 Sutphen Court
Hilliard, Ohio 43026
(800) 888-1897

Campbell Equipment
5151 Canal Rd.
Cleveland, Ohio 44125
(216) 696-1155

OHIO DEPARTMENT OF COMMERCE BACKFLOW PREVENTION MANUAL

INTERNET WEB SITES

<u>SITE</u>	<u>WEB ADDRESS</u>
American National Standards Institute	www.ansi.org
American Water Works Association	www.awwa.org
American Society of Sanitary Engineers	www.siteflow.com
BAVCO	www.bavco.com
Centers for Disease Control	www.cdc.gov
Conbraco Backflow Preventers	www.conbraco.com
Factory Mutual	www.factorymutual.com
Febco Backflow Preventers	www.cmb-ind.com
Flowmatic Backflow Preventers	www.flomatic.com
Hot Box Enclosures	www.hot-box.com
National Fire Protection Association	www.nfpa.org/welcome
Ohio EPA Approved Backflow Preventer List	www.epa.state.oh.us/ddagw/eng.html
Ohio DOC - Certified Tester List	www.com.state.oh.us
Operator Training Committee of Ohio, Inc.	www.ohiowater.org
Safe-T-Cover Enclosures	www.safe-t-cover.com
United States Environmental Protection Agency	www.epa.gov/safewater/
University of Florida, TREEO Center	www.doce.ufl.edu/treeo/backflow
University of Southern California Foundation on CCC & Hydraulic Research	www.usc.edu/dept/fccchr
University of Wisconsin	www2.siu.edu/welcome
Watts Industries	www.wattsreg.com
Wilkins-Zurn Backflow Preventers	www.zurn.com

REDUCED PRESSURE BACKFLOW PREVENTION DEVICE

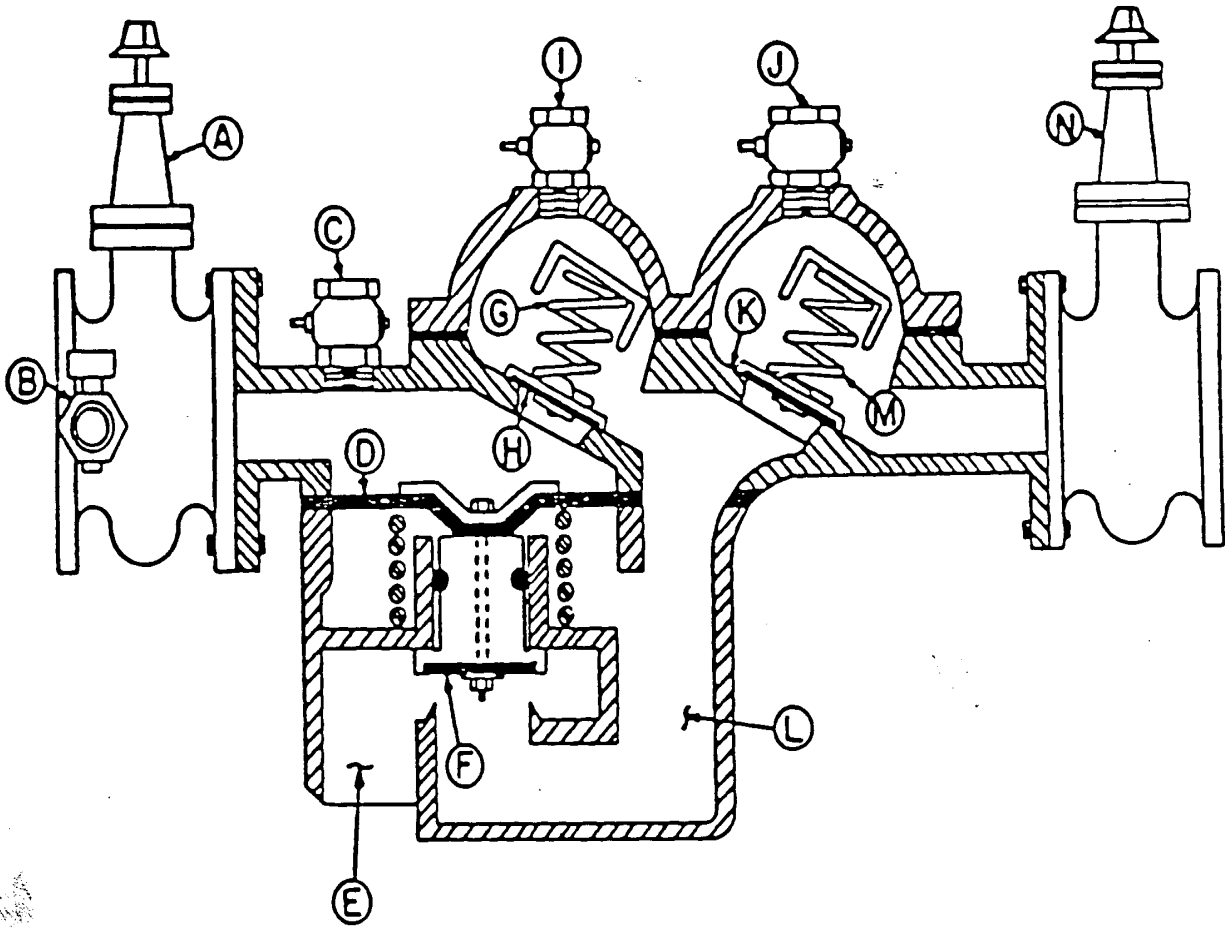

A	
B	
C	
D	
E	
F	
G	
H	
I	
J	
K	
L	
M	
N	

DOUBLE CHECK VALVE ASSEMBLY

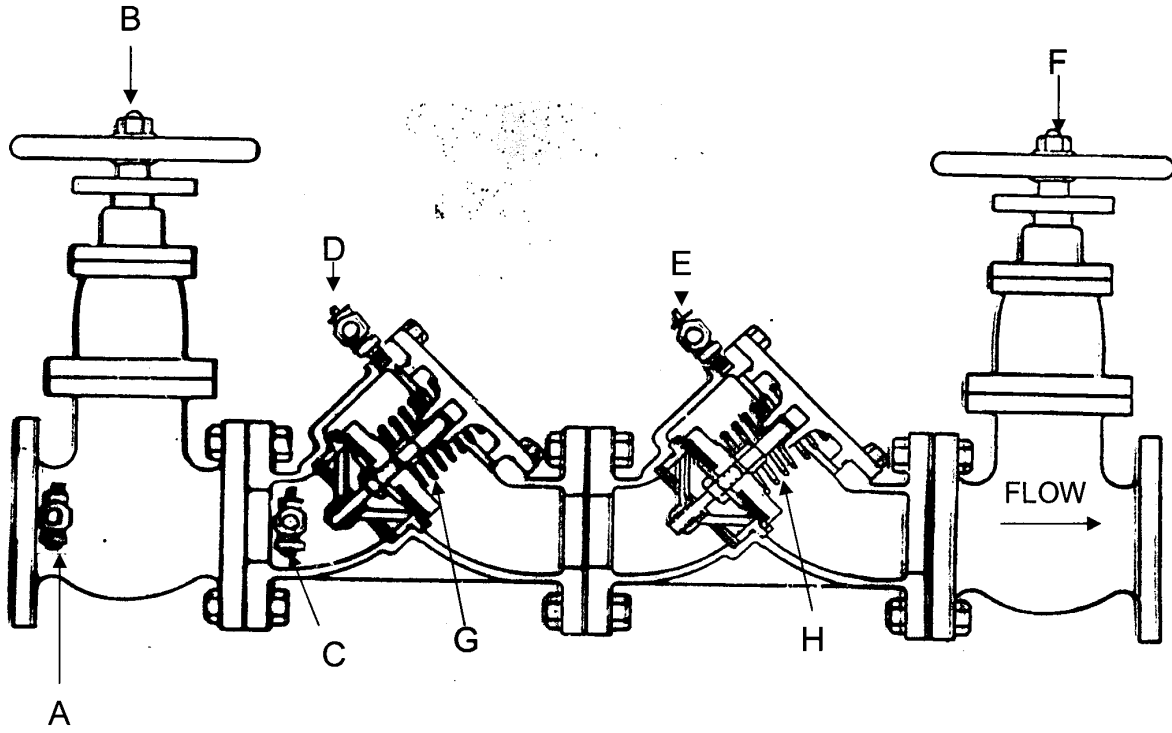

A	
B	
C	
D	
E	
F	
G	
H	

NAME	PRESSURE VACUUM BREAKER
-------------	--------------------------------

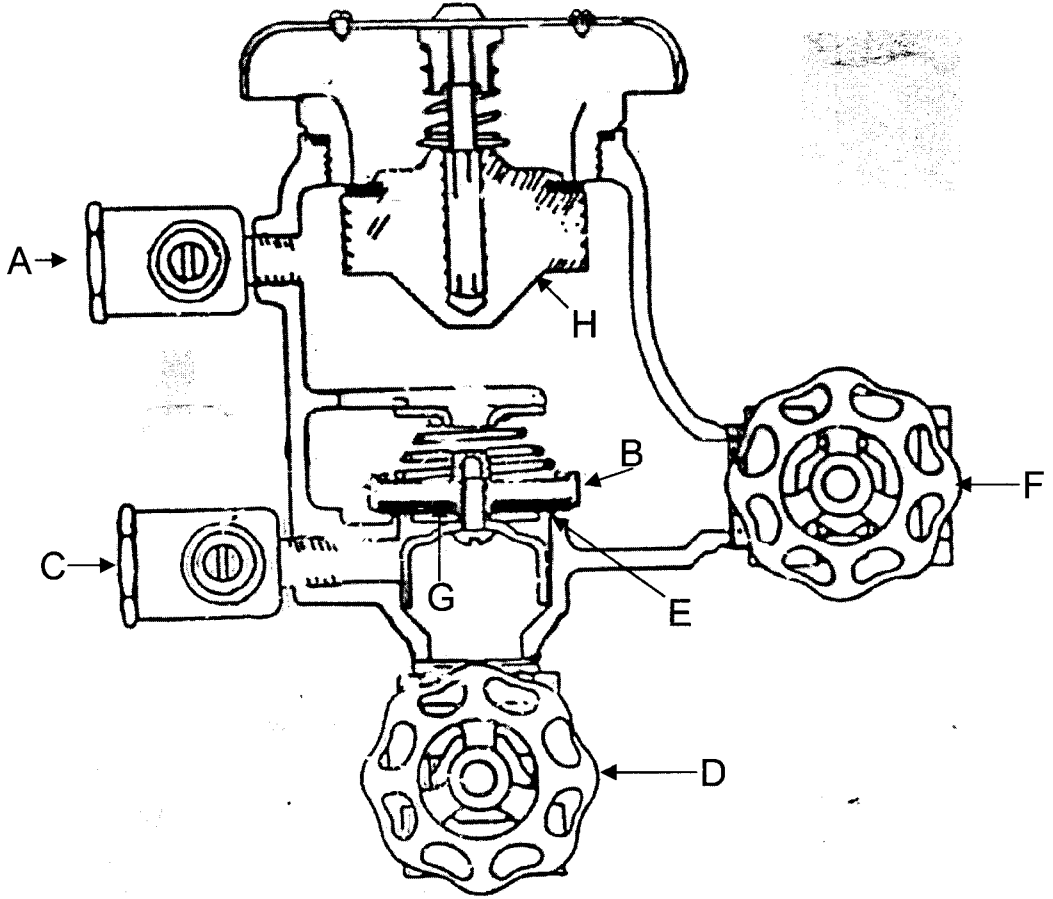

A	
B	
C	
D	
E	
F	
G	
H	